



PTCarPhone 6 User Manual



www.peitel.com
www.malux.se



Table of Contents

Introduction	4
Safety Instructions	4
Instructions for Use	5
PTCarPhone 6 Series - Models	5
About this User Manual	6
Icons for Warning Messages and Notices	6
Menu Navigation	7
Calling up the Start Menu Items	7
Selection Lists	7
Display Symbols	8
Turning the Device On and Off	8
Symbols on the Electronics Box	8
Status Indication on the Electronics Box	9
Bridge	9
First Steps	10
General Tips	11
Editors	12
Character Tables	13
Connection Plan	14
Precautionary Measures and Installation	15
Precautionary Measures	15
Microphone Mounting	15
Optional Connections	16
Additional Required Hardware	16
Instructions for Mounting	16
Sequence of Installation	17
Setting up the PTCarPhone	18
Inserting the SIM Card	18
Inputting PIN	18
Setting the Delay Time	18
Turning on Virtual Ignition	18
Adjusting Display Brightness	18
System Menu	19
Calling-up the Device Info	19
Performing a Software Update (OTA: Over-the-Air)	19
Access to the System Configuration Menu	19
Configuration of the USB Interface	20
Setting up Usage Restrictions (Operation Modes)	20
Changing the Delay Timer	21
Activation of the Virtual Ignition	21
Resetting the PTCarPhone to Factory Defaults	21
Digital Inputs and Outputs (I/Os)	22
Activation of the Hands-Free System for the Intercom Function	22
Activation of Purchase Features	23
Setting up the WiFi feature	24
Speed Dial Menu	25
Adding Speed Dial Numbers	25
Deleting a Speed Dial Number	25
Using a Speed Dial Number	25
Settings Menu	26
Adjusting Display and Keypad Illumination	26
Adjusting the Display Brightness	26
Call Settings	26
Calling Line Identification Restriction	27
Call Waiting	27
Automatic Answer	27
Incoming Call	28
Call Duration Display	28
Setting up a Call Divert	28
Enabling the SMS Signal Tone	28
Adjusting the Ringer Volume	28
Selecting a Ring Tone Melody	29
Setting the Sensitivity for the Hands-free Microphone	29

Table of Contents

Security Codes.....	29
Select a PIN Code Request Mode	30
Changing the Security Codes	30
Automatic Network Selection	30
Selecting a Mobile Phone Network.....	31
Selecting a Network Technology	31
Internet Access Configuration.....	31
Setting Date and Time	32
Changing Date and Time Display Modes.....	32
Language Selection.....	32
Phone Book Settings	33
Access Memory Status.....	33
Copying Phone Numbers from the SIM Card to the Phone Book.....	34
Sorting Contacts by First Name or Surname.....	34
Setting up Direct Call.....	34
Accessing SMS Settings.....	35
Phone Book Menu	36
Editing Contacts in the Phone Book.....	36
SMS Menu	37
Writing an SMS Message	37
Opening Received SMS Messages.....	38
Deleting SMS Messages	38
Replying to SMS Messages	38
Forwarding SMS Messages	38
Calling a Phone Number Retrieved from an SMS Message.....	38
Saving a Phone Number from an SMS Message.....	39
Saving SMS Messages	39
Retrieving the Memory Status.....	39
Opening Saved SMS Messages	39
Call Register Menu	40
Opening the Call Register.....	40
Saving a Phone Number from the Call Register.....	40
Calling a Phone Number from the Call Register	40
Sending an SMS Message to a Phone Number from the Call Register.....	40
Redialling.....	41
Deleting Call Register Lists	41
Additional Information	42
Toggling	42
Features of the GPS Module	42
Setting the Time via GPS.....	42
The Second Handset.....	42
Forwarding a Call from one Handset to the Other	43
The Intercom Feature.....	43
Using the PTCarPhone as a Modem.....	43
Scope of supply.....	44
Accessories	44
Care and Cleaning Tips	44
Technical Data.....	44
Approvals.....	45
Technical Details of the Connections.....	46
Disposal	46
Declaration of Conformity.....	46
Support	47
Support	47
Menu Overview	48

Safety Instructions

Emergency Call 112/911/999

There is no guarantee that the emergency call will function in all situations!

For this reason you should not depend only on the device for crucial communication (e.g., medical emergencies).

You can only telephone with the device when it is turned on and in an area with sufficient signal strength.

Emergency calls can only be made with a SIM card activated by the mobile phone service provider. In some circumstances you cannot be connected in all mobile phone networks.

It is possible that emergency calls can also not be made when certain network services and/or telephone functions are activated or deactivated.

Traffic Safety

Phoning while driving can distract from traffic and cause accidents! The same is true for using other functions of the telephone.

Only use the hand-free function of the device while driving. The handset must only be used when the engine is turned off. The hands-free equipment is only active if the handset is in its cradle.

Always fasten the handset in its cradle; do not lay the handset on the seat or anywhere that it could move in the event of a collision or sudden braking.

Please follow the current laws of the country where you are located.

Operating Environment

When using the telephone, observe the legal regulations and local restrictions. Turn off the device wherever you are requested by the appropriate warnings, e.g. near fuel and/or flammable chemicals.

Health

The function of medical devices, such as a heart pacemaker, can be disturbed. Therefore always keep a minimum distance of 20 cm between the antenna of this device and the pacemaker. During a conversation hold the phone on the ear farther away from the pacemaker. For more information consult your doctor.

If interfering noises occur in connection with a hearing aid, please contact the manufacturer of the hearing aid or your hearing care professional.

The PTCarPhone is Not a Toy

Do not let children play with the PTCarPhone. The spiral cable of the handset or swallowed small parts can lead to suffocation!

Take Care of your Hearing

Only set the volume as loud as necessary and avoid exposing your hearing to loud volumes over a longer period of time.

Do Not Drown Out Warning Signals

Awareness of the warning signals of others on the road must not be adversely affected by the telephone. Set the volume of the telephone appropriately so that you can always be clearly aware of warning signals from the surroundings, for example horns and sirens.

Safe Installation

Avoid mounting all components in the deployment area of the airbag. Fasten the PTCarPhone and accessories sufficiently so that in the case of sudden, hard braking they cannot cause damage flying around. Use the included fastening material or suitable materials for the corresponding surfaces for this.

Secure LTE Operation

During operation, ensure to keep a distance of at least 20 cm to the LTE antennas.

Introduction

Instructions for Use

Electronic Devices

High frequency signals can adversely affect the function of improperly installed or insufficiently shielded electronic systems in the vehicle in certain circumstances.

Accessories

Only use accessories that are approved for use on this device. The use of non-approved accessories voids the warranty. Ask your dealer or the manufacturer about approved accessories.

Service, Installation and Repairs

Only qualified specialists may service, install and/or repair this device. The device must not be opened. Any manipulation on the device is not allowed and voids the warranty.

Network Services

Some functions of this device are designated as network services. Network services are added services that are made available by the mobile phone service provider at the request of the user.

Before the user can use these, authorization must be given for the use of these services from the mobile phone service provider. Some networks may not support all services and/or functions.

Environmental Influences: Water & Dust

The PTCarPhone and all accessories are neither dustproof nor waterproof. Make sure that the PTCarPhone is always protected from moisture and from water penetrating the vehicle. Regular cleaning of exposed accessory parts and the interior of the vehicle can prevent the penetration of dust particles in the housing. A soft, lint-free, dry cloth is suitable for cleaning.

Switching off the device

The device must always be shut down properly. To do this, press and hold the red button on the keypad. The device may only be disconnected from the power supply after it has been completely shut down. Otherwise, damage to the device may occur for which we, as the manufacturer, cannot accept any liability.

If you are an installer, be sure to pass this information on to the end users.

PTCarPhone 6 Series - Models



Feature	PTCarPhone 6 Europe	PTCarPhone 6 North America
Mobile radio standards	LTE, UMTS, GSM	LTE, UMTS
Frequency bands	LTE: B1(2100), B3(1800), B7(2600), B8(900), B20(800), B28A(700) UMTS: B1(2100), B3(1800), B8(900) GSM: B3(1800), B8(900)	LTE: B12(700), B14(70), B4(1700), B2(1900), B5(850), B13(700), B66(1700/2100), B71(600) UMTS: B2(1900), B4(1700), B5(850)
Wireless interfaces	LTE, WiFi, UMTS, GSM	LTE, WiFi, UMTS
Hardware interfaces	RS232 with V24 level, USB 2.0	RS232 with V24 level, USB 2.0
Audio	Clear Voice & Sound Technology™	Clear Voice & Sound Technology™
Positioning	GPS, Glonass, Beidou, Galileo, QZSS	GPS, Glonass, Beidou, Galileo, QZSS
LTE modem	Over mini USB connection	Over mini USB connection
WiFi hotspot	Yes	Yes
Digital I/Os	6 inputs and outputs	6 inputs and outputs

Introduction

About this User Manual

This user manual describes the PTCarPhone 6 Series with the software versions v.6.01.04 (Platform 6) and v.01.22 (HA59) and previous versions. Future firmware versions might contain features that are not included in this user manual.

Depiction of Keys and Icons

Keys and icons (e.g.  or ) might change in this user manual as well as on the phone display their colour (for example black turns into white), to assure their visibility and legibility on changing backgrounds. Function key symbols are printed in this user manual using the font VistaSansLight e.g. System, Speed D.

Step-by-Step Instructions

The chapter **First Steps** describes important and comprehensive operations in Step-by-Step format.

Once you are familiar with the main features of the PTCarPhone, it will be easy for you to follow the pattern of menu paths, which are used in the other chapters. Example:

Main menu > **sub menu** > **sub menu**

Bold printed terms of the menu paths are menu points, text in *italic* are instructions and regular printed text stands for keys. Example:

Main menu > **sub menu** > *device code input* > **sub menu** > function key Options > call key 

Icons for Warning Messages and Notices

Hazard symbol: Warning



Marks danger of injury and life

Hazard symbol: Caution



Danger of destruction of the product and other objects

Advice symbol: Notice



Marks important notices for hassle free usage of the product.

Advice symbol: Tip



Marks information worth knowing on handling the product.

General Drawing

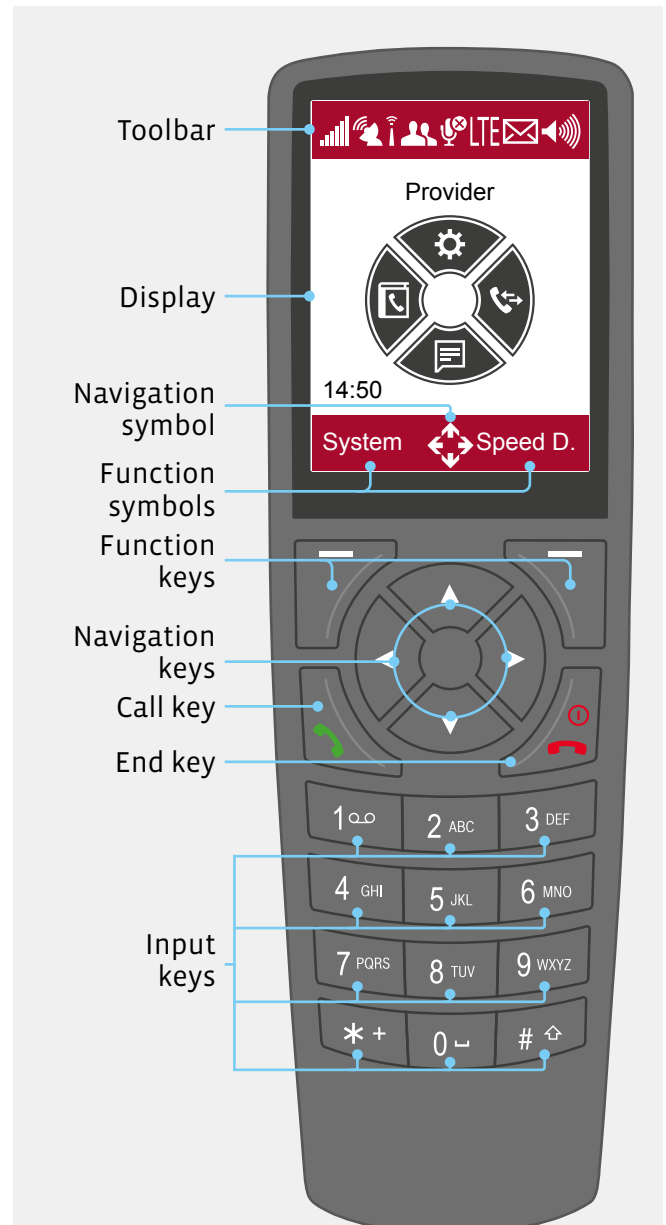



Menu Navigation

Navigating the phone menu is done using the navigation keys (up ▲, down ▼, right ►, left ◀) and the function keys (also known as soft keys).

The respective function of the function keys is shown on the bottom of the display on the left and right side of the navigation symbol. The function symbols change as needed (e. g. System, Speed D., OK, Cancel, Back, Name).

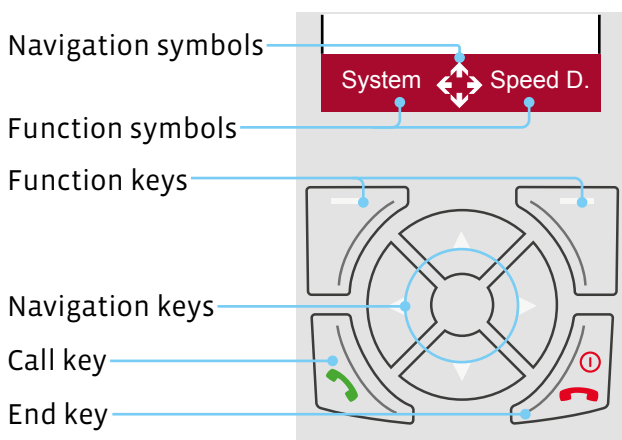
The navigation symbol ◀ indicates, which navigation keys are currently active.



The call key  is used for establishing outgoing calls or accepting incoming calls.

The end key  is used for ending calls, turning the phone on and off and returning to the start screen when navigating through the phone menu.

Calling up the Start Menu Items

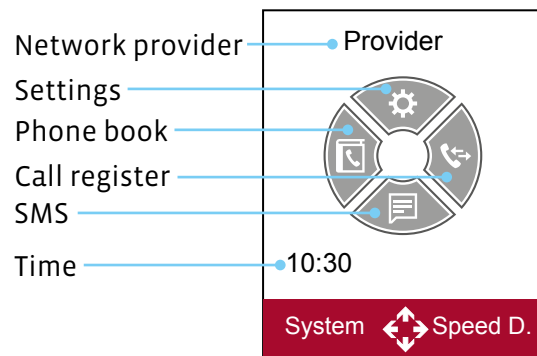

The start menu items Settings [▲], Phone book [◀], SMS [▼] and Call register [►] are called up using the four navigation keys.

The system and speed dial menus can be opened from the start menu with the System and Speed D. function keys.

Selection Lists

One or more options can be chosen, activated or deactivated from the selection lists. Control the desired option with the navigation keys and select your choice with the OK function key.

 Selected option

 Not selected option



Display Symbols

Symbol	Description
	Signal strength low
	Signal strength high
	Data transmission via the GPRS or EDGE network
	Data transmission via the UMTS, HSDPA and HSPA+ network
	Data transmission via the LTE network
	GPS: No satellite
	GPS: 2D-Fix, 3D-Fix
	WiFi hotspot activated
	Private mode, phoning using handset
	Hands-free mode, phoning via hands-free system
	Microphone mute (MUTE)
	New text message (SMS)
	Only one free SMS storage location
	Volume low
	Volume high
	Phone book entry - Business
	Phone book entry - Mobile
	Phone book entry - Private
	Phone number
	Date
	Time
	Active navigation keys are shown

Turning the Device On and Off

The PTCarPhone is automatically started when the vehicle ignition is turned on.

If the Virtual Ignition function is activated (see also “**Activation of the Virtual Ignition**” on page 21), the PTCarPhone starts when the engine is turned on. The PTCarPhone turns off when the ignition or the engine is turned off and after the subsequent delay time (see also “**Changing the Delay Timer**” on page 21) has elapsed.

Independently of this, the PTCarPhone can also be turned on or off by holding down the end key  /  for an extended time.

Symbols on the Electronics Box

Connections

Symbol	Description
I/O	I/O connections
LTE	LTE antennas
MIC	Handsfree microphone
PWR	Power supply (cable set)
GPS	GPS antenna
USB	Mini USB connection
IF1	Handset I
IF2	Handset II
WiFi	WiFi antenna

LEDs

Symbol	Description
WiFi	WiFi status indicator
Info	Mobile network status
PWR	Power supply status

Introduction

Status Indication on the Electronics Box

Three LEDs on the electronics box serve as status indicators.

WiFi

Status indication of the WiFi hotspots.

LED	Description
Green	WiFi active, with internet connection
Orange	WiFi active, no internet connection
Red	WiFi not active, error at initialization

INFO

This green LED indicates the state of the mobile phone network.

LED	Description
Off	Device switched off
Flashing, 1 s on, 2 s off	Registered in idle
Flashing time depends on network condition in order to minimize power consumption	Registered in idle with power saving
Permanently on (Colour: Orange)	Device not registered in the network

PWR

Status indication of the power supply.

LED	Description
Green	Power supply voltage ok
Red	Power supply voltage faulty

Bridge

Bridge is the online platform for remote configuration of the PTCarPhone and related products.



For registration, visit <https://bridge.peitel.de/en/>.

There are three different modes of registration which are indicated in the Device info:

- IoT: 0 The device is not registered with Bridge.
- IoT: 1 The device is registered with Bridge and the positioning service (GPS) is inactive.
- IoT: 2 The device is registered with Bridge and the positioning service (GPS) is active.

Advantages of Bridge

- Completely free - no monthly costs for access and use of the online platform
- No installation of additional software or hardware necessary
- Works with all common internet-capable devices (PC, tablet, smartphone)
- Cloud Service - independent of the operating system or location of the device
- API access - individual connection to existing software and/or systems possible
- Convenient management of contacts and phone books

Features of Bridge

- Device status and configuration
- Assigning speed dialling/direct dialling entries
- Launching of software updates
- Changing settings remotely for...
 - ... Operating modes (comfortable cost control)
 - ... Delay-timer
 - ... Virtual ignition etc.
- Controlling an setting digital inputs an outputs
- Administrating a single device or entire device groups
- GPS real-time tracking with map display
- Encryption



First Steps

Content



- Phoning
- Accepting a Call
- Rejecting a Call
- Regulating the Call Volume
- Muting the Microphone
- Changing from Hands-free Mode to Private Mode
- Creating a Contact
- Calling a Contact
- Adding Phone Number to Contact

Please find detailed descriptions of all phone features on page 18 ff.

Phoning

1. Enter the phone number with the input keys .
2. Press the call key .
3. First the message “Dial number” appears on the display and after the connection is made, the message “Connected with”.
4. Talk.
5. To end the call press the end key .



Accepting a Call



1. For an incoming call, press the Accept function key or the call key .
2. To end the call press the end key .

Rejecting a Call

For an incoming call, press the Cancel function key or the end key .

Regulating the Call Volume

The volume during a call is regulated with the navigation keys  and .



The PTCarPhone can differentiate with the volume control between private mode  and hands-free mode .



NOTE:

In private mode the volume of the handset loudspeaker is regulated. However, the volume of the external loudspeaker is set in hands-free mode.

Muting the Microphone

During a call, the active microphone can be muted and reactivated using the function key MUTE. When muted, the mute symbol  appears instead of the data transmission symbols  or LTE in the toolbar of the display.

Mute is automatically cancelled after the call is ended.

Changing from Hands-free Mode to Private Mode

If the handset is in the cradle hands-free mode  is active and calls go over the hands-free system (hands-free microphone and external loudspeaker).



When the handset is lifted the PTCarPhone switches to private mode , i.e. from the hands-free system to the handset.













NOTE:

For ring tones the PTCarPhone always uses the external loudspeaker.

Creating a Contact

A contact consists of “First name”, “Surname” and up to three phone numbers, which can be assigned to the categories business , mobile  or private .

Phone book > function key Options > **Add contact**





1. To open the phone book, press the navigation key .
2. Press the Options function key.
3. Select “Add contact” with the navigation key .
4. Press the OK function key.
5. Enter the first name with the input keys  (also see Chapter “Editors”).
6. Press the navigation key .
7. Enter the surname with the input keys .
8. Press the Next function key.
9. Select a phone number category (business , mobile  or private ) with the navigation key .
10. Enter the phone number with the input keys .

Introduction

11. This process is repeated for more phone numbers if necessary.
12. End the process with the OK function key. The message “Entry saved” is displayed.



Calling a Contact

Phone book > paging ▲ ▼ > Call key 

1. Press the navigation key ◀, the phone book opens.
2. Scroll with the navigation keys ▲ and ▼ until the contact to be called is marked.
3. Press the call key , the phone book entry for the selected contact opens.
4. Select the desired phone number with the navigation keys ▲ and ▼ (business , mobile  or private ).
5. Press the OK function key.
6. First the message “Dial number” appears on the display and after the connection the message “Connected with”.



NOTE:

When you take the handset out of the cradle, a call can be made in private mode  with the handset. When the handset is hung in the cradle, hands-free mode  is activated.

Adding Phone Number to Contact



Phone book > function key Options > Edit contact

1. To open the phone book, press the navigation key ◀.
2. Scroll with the navigation keys ▲ and ▼, to select the contact.



TIP:

The phone book shortens when you input the first letter, or several letters, of the searched name with the input keys .

3. Push the Options function key when the desired contact is marked.
4. Select “Edit contact” with the navigation key ▼.
5. Press the OK key.
6. Press the Next function key.
7. Select a free phone number category with the navigation keys ▲ and ▼ (business , mobile  or

private .

8. Enter the new phone number with the input keys .
9. Press the OK key. Editing is completed and the contact is saved.

General Tips

- Always enter phone numbers as follows
+[country code][local area code][phone number]

Example: +491711234567890

- Inserting special characters for pauses and other functions: By repeatedly pressing the * key, pauses and other functions can be initialised.

The symbols represent the following functions:

* = For GSM commands, device codes or DTMF tones (example: *#06# or *135#)

P = Sends the “pause” command via DTMF

, = inserts a slightly longer „pause“ between DTMF tones

Introduction

Editors

Using the Editors in Text Mode

The editors are used for the input of text and numbers with the input keys  of the handset. In the top right of the display it is displayed whether numbers (123) or letters (abc, Abc or ABC) are input.

To input letters and punctuation marks you can page through the available letters and punctuation marks by briefly pushing the corresponding input key .

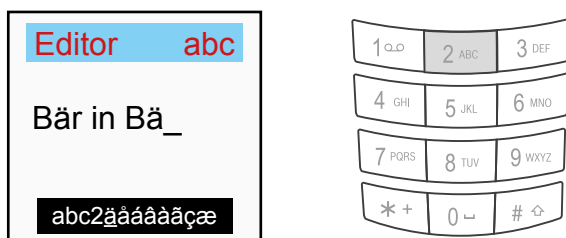

Example: Input window with input key 2

During the input a black bar is shown on the bottom edge of the display, which displays the characters available for the input key used.

Input key

Change between upper case **ABC**, lower case **abc** and capitalized **Abc**.

Input keys 0 - 9, press key briefly

Output according to character table left of cursor

Input keys 0 - 9, press key longer

Direct output of the character left of cursor

Function key Delete, press key briefly

Delete the character left of the cursor

Function key Delete, press key longer

Delete the entire text field contents

Function key Back (Text field is empty)

Leave the editor without saving the data

Function key OK

Leave the editor with saving data

Upwards navigation key ▲

Cursor _ in the previous rows

Left navigation key ◀

Cursor _ one character back

Downwards navigation key ▼

Cursor _ in the next rows

Right navigation key ▶

Cursor _ one character forwards

Introduction

Character Tables

Lower Case Mode

Key	1x	2x	3x	4x	5x	6x	7x	8x	9x	10x	11x	12x	13x
1	.	,	'	?	!	"	1	-	()	/	:	_
2	a	b	c	2	ä	â	à	ą	ç	ć	æ		
3	d	e	f	3	é	è	ę	€					
4	g	h	i	4	ï								
5	j	k	l	5	ł	\$							
6	m	n	o	6	ö	ñ	ń	ó	ø				
7	p	q	r	s	7	ß	ś						
8	t	u	v	8	ü	ù							
9	w	x	y	z	9	ź	ż						
0	␣	.	,	=									
*	*	#	;	<	>	&	@	£	ı	~			

Upper Case Mode

Key	1x	2x	3x	4x	5x	6x	7x	8x	9x	10x	11x	12x	13x
1	.	,	'	?	!	"	1	-	()	/	:	_
2	A	B	C	2	Ä	Å	À	Ą	Ç	Ć	Æ		
3	D	E	F	3	É	È	Ę	€					
4	G	H	I	4									
5	J	K	L	5	Ł	\$							
6	M	N	O	6	Ö	Ñ	Ń	Ó	Ø				
7	P	Q	R	S	7	ß	Ś	¥					
8	T	U	V	8	Ü								
9	W	X	Y	Z	9	Ź	Ż						
0	␣	+	=	0									
*	*	#	;	<	>	&	@	£	ı	~			

Connection Plan

- 1 Handset HA59
- 2 Cradle for HA59
- 3 Loudspeaker
- 4 Electronics box (TPU)
- 5 Hands-free microphone
- 6 2.5 m extension cable for handset
- 7 Cable set
- 8 Brief instructions and installation instructions (not shown)

- A 2x LTE antenna connection (SMA)*
- B Main connector
- C GPS antenna connection (SMA)*
- D WiFi antenna connection (SMA)*
- E SIM card holder (Valid SIM card required)

* Antennas are not included in the scope of delivery

- 1 Connections for handsets (both handset connections are identical)
- 2 Speaker connection
- 3 Connection for hands-free microphone
- 4 Mini USB connection (Modem connection)
- 5 I/O connection

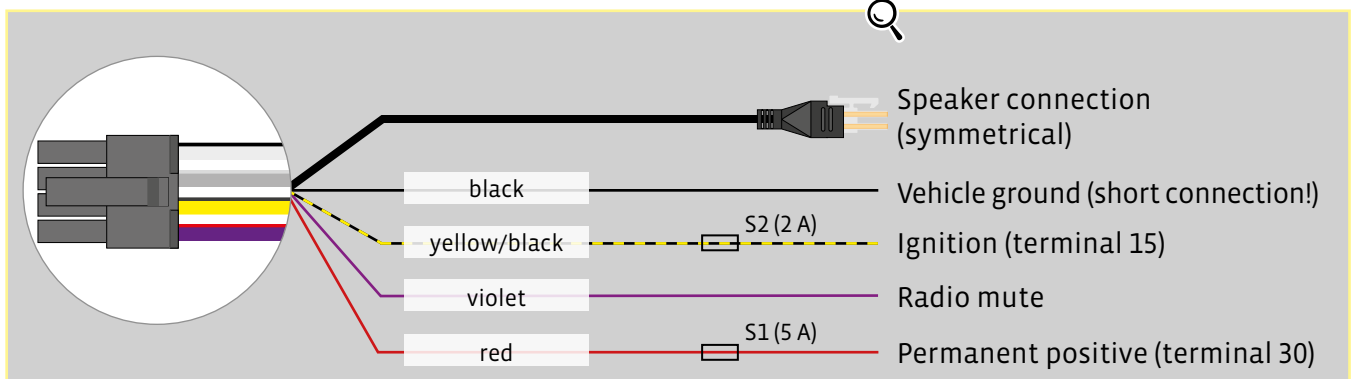
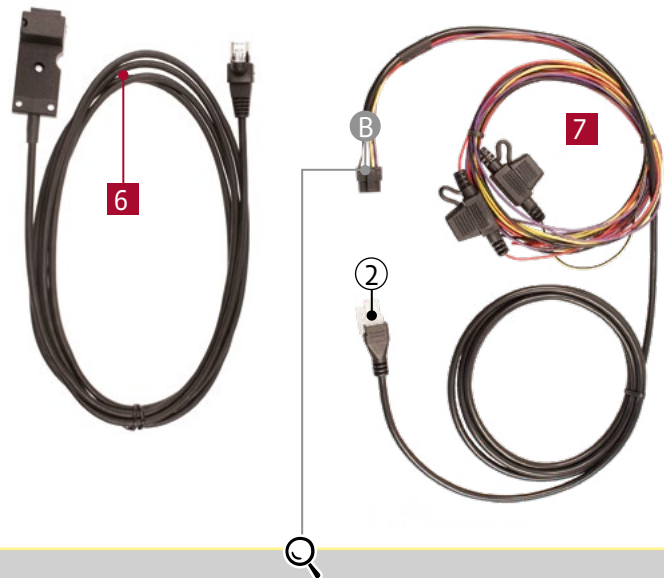

Precautionary Measures and Installation

Precautionary Measures

CAUTION:

Non-compliance with these instructions can cause damage to the device and to the vehicle.

Qualified installation personnel

The device must only be installed in the vehicle and serviced by qualified specialists.

Consequences of incorrect installation

Incorrect installation can cause damage to the vehicle. Incorrect assembly or service can have hazardous consequences and can void the warranty and possibly the operating permit of your vehicle.

Airbag

With vehicles that are equipped with an airbag, remember that the airbag fills with a strong force. Do not install any components in the area impacted by the filled airbag.

Antennas

Before start-up of the device, the antennas must be connected (antennas are not included in the scope of supply). The device must not be operated without antenna(s), since this can lead to the destruction of the device.

Connection to the power supply of the vehicle

In some cases settings must be done in modern vehicles after attaching the battery. Absolutely be sure to refer to the operating manual of your vehicle for this.

Environmental influences: Water and dust

The PTCarPhone and all accessories are not waterproof. Make sure that the PTCarPhone is always protected from moisture penetrating the vehicle. Prevent penetration of dust particles in the housing by cleaning regularly.

Microphone Mounting

Mounting location for the microphone

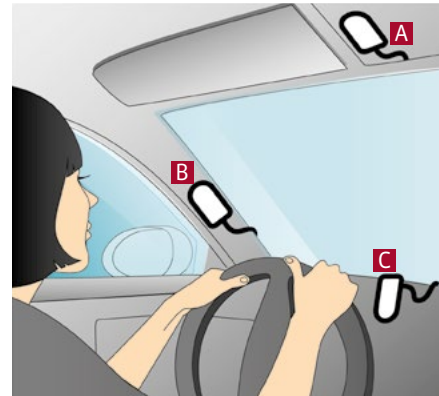

- A** Optimum position
- B** Alternative position
- C** Limited suitability

Microphone alignment



- 1** Maximum sensitivity
- 2** Adhesive tape for smooth (flat) surfaces

Instructions for Mounting

Optional Connections

I/O cable installation set (accessory)

CAUTION:

The respective operating voltage of the vehicle electrical system is applied to the I/O connection. Please keep this in mind when selecting your I/O components.

The six programmable inputs and outputs of the PTCarPhone offer the possibility of the phone being used as a control unit for vehicle accessories. The accessory set contains 12 strands and a plug housing. The crimped contacts of the strands are pushed into the plug housing as needed.

Connection specifications:

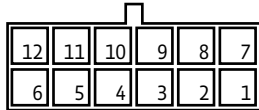

I/O connection (Top view)

PIN	Signal
1, 2, 3	GND
4, 5, 6	U _{B+}
7 to 12	I/O 1 to 6

Types of connection:

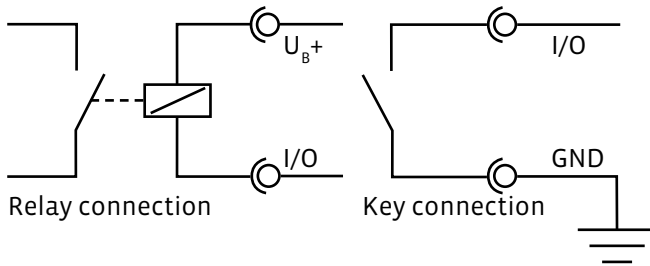

Additional Required Hardware

LTE antennas

Two LTE antennas or LTE MIMO antenna with SMA connector (not in scope of supply).

GPS antenna

GPS antenna with SMA connection (not included in the scope of supply). Power supply: 3.3 V, max. 50 mA;

WiFi antenna

WiFi antenna with SMA connection (not included in the scope of supply).

Recommended Antennas

High quality antennas for the vehicle's interior and exterior of **Panorama Antennas** can be enquired from pei tel.

Antennas of other manufacturers:

- LTE: Hirschmann Magnetic Mount Antenna CEL 70 26 RD M/SMA/2.5 (Order No. US: HCEL-MX-0150A-02, Order No. EU: 955 006-002), cable length 2500 mm
- GPS: Taoglas Titan GPS/GALILEO Antenna AA.105 (Order No. AA.105.301111), cable length 3000 mm
- WiFi: Proant Ex-It 2400 28 SMA (Order No. PRO-EX-347), no cable

SIM card

Mini SIM card with mobile phone contract with phone and data plan, supporting SMS, LTE and VoLTE. This is available from your mobile phone provider.



TIPS:



- We strongly recommend to use a SIM card with at least 200 MB data volume per month to be able to cover all functions of the device, inclusive Bridge.
- If the PTCarPhone should be operated with the same telephone number as the mobile phone of the user, it is recommended to use a so-called multi SIM card. For this, contact your mobile phone provider.
- It is recommended to make sure before assembly, whether the electronics box should be positioned so that easy access to the SIM card is provided.

Screws and adhesive tape

Depending on the installation situation it can be necessary to fasten the electronics box, the handset and the accessories with other fastening material than that which is partially supplied. Please do not forget: Safety first! Nevertheless, it is recommended to pay attention to aesthetics.

Sequence of Installation

1. Become familiar with the connections (see also **“Connection Plan” on page 14**). Disconnect the negative terminal of the vehicle battery while following the safety instructions of the vehicle manufacturer.
2. Select the installation locations for the electronics box, handset, loudspeaker, hands-free microphone and the antenna(s), paying attention to the cable lengths and installation instructions and mount the components.
When drilling holes make sure that the vehicle is not damaged. Use cable bushings on sharp-edged holes.
3. Install the included hands-free microphone. Make sure that air flow from the vents is not in the direction of the microphone. Also refer to **“Microphone Mounting” on page 15**.
Then install the loudspeaker (a good location is the passenger footwell). During installation of the microphone and loudspeaker make sure of sufficiently large spatial separation, to avoid acoustic feedback.
4. Connect the power supply cable (red) on the permanent positive and the ignition input (yellow/black) to the ignition *, if present. Do not connect the ignition input (yellow/black) onto permanent positive, since this limits the scope of function of the device (see also **“Changing the Delay Timer” on page 21**). Connection of the ground cable is done directly to the vehicle battery, the central ground point (ground block) or a part of the vehicle body.

* For vehicles without ignition wiring it is recommended at the end of the installation to activate the “Virtual ignition” function.
5. Connect the violet cable with the mute input of the car radio. This ensures automatic radio mute switching for incoming and outgoing calls.
6. Insulate unused cables so no short circuits can occur.
7. Connect the individual components of the device with each other using the plug and screw connections (see **“Connection Plan” on page 14**).
8. Check the total installation and insert a valid SIM card. Connect the vehicle battery.
9. For vehicles **with ignition wiring**: Turn on the ignition. The device now turns on and requests the input of the PIN (if this was not deactivated on the SIM card).
For vehicles **without ignition wiring**: Turn the device on with the end key  /  on the handset.
10. Enter the PIN. The telephone is now registered in the network.
11. Make a call in order to check the basic functions.
12. Check whether there is new software available and if necessary perform a software update. Downloading of software updates can incur costs, depending on the mobile phone contract.
See also **“Performing a Software Update (OTA: Over-the-Air)” on page 19**.
13. If desired, make personal settings on the device (see chapter **“Setting up the PTCarPhone” on page 18**) and finish the installation.

Setting up the PTCarPhone

Inserting the SIM Card

A valid and activated SIM card is required to operate the device. This is available from your mobile phone provider. It saves all the important data of your connection.

To open the SIM card holder, push the round button in the housing with a pointed object. Place the SIM card in the holder and push it back in the electronics box.

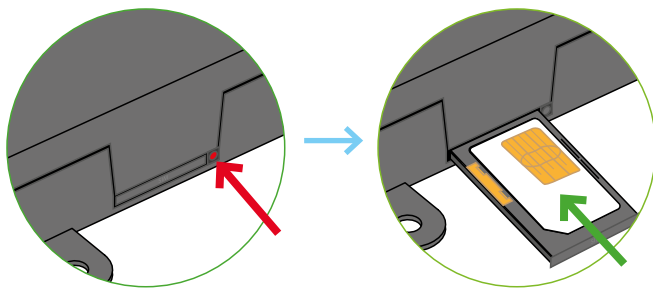

NOTES:

- Insert the SIM card only if the device and the vehicle ignition are turned off.
- Make sure to insert the SIM card holder in the correct position. Closing does not require strong force.
- If a piece of plastic remains on the edge of the SIM card when taking it out, it is necessary to remove this before inserting the SIM card.

Inputting PIN

If a PIN is required it will be requested with an appropriate message when starting the device.

Enter the PIN using the input keys  and confirm with the OK function key. Corrections can be made with the Delete function key.

PIN input is shown with asterisks so that it cannot be seen. The subsequent registration in the network can take a few seconds.

After entering an incorrect PIN three times the SIM card is blocked. The PUK is requested for unblocking.

Setting the Delay Time

After turning off the ignition the device runs for the set delay time and then turns off.

Use the following menu path to set the delay time:

System > Configuration > device code input > Delay timer

The device code at delivery is: 0000

See also “Changing the Delay Timer” on page 21.

Turning on Virtual Ignition

In modern vehicles without ignition wiring it is recommended to activate the Virtual ignition function.

System > Configuration > device code input > Virtual ignition

The device code at delivery is: 0000

See also “Activation of the Virtual Ignition” on page 21.

Adjusting Display Brightness

Adjustment of the display brightness in illuminated state (Active) and in dimmed state (Inactive).

Settings > Display > Brightness

See also “Adjusting the Display Brightness” on page 26.

Calling-up the Device Info

The device info lists the software versions of the handsets and the PTCarPhone. Additionally, the IMEI number, the IMSI number, the MCC/MNC and IoT (registration status at BRIDGE) are displayed.

System > Device Info

Performing a Software Update (OTA: Over-the-Air)

Software update for handset and PTCarPhone are using the internet access of the mobile phone network. For this reason, the internet access needs to be configured (see also “**Internet Access Configuration**” on page 31).

System > Device Info > Update > device code input > update process

For the software update, the device code is requested (see also “**Security Codes**” on page 29). After the device code input, the device checks, whether new software versions are available for the handset and the PTCarPhone. If so, the new software is downloaded and after that, the installation process is started. After the installation, the car phone is rebooted.

CAUTION:

Make sure that the software installation process never gets interrupted.

NOTES:

- pei tel cannot guarantee that during an update, all data stored on the phone (e.g. customised logo, contacts and text messages) and settings will be preserved. Do not keep important phone numbers on the PTCarPhone only.
- Downloading of software updates can incur costs, depending on the mobile phone contract.

Access to the System Configuration Menu

The system configuration menu lists settings for special functions of the PTCarPhone. To access this part of the phone menu, the device code is needed.

System > Configuration > device code input

Options

USB interface:	Configuration of the USB interface
Operation mode:	Changing of the operation mode
Digital I/O:	Setting up digital inputs and outputs
Delay timer:	Changing the delay timer
Virtual Ignition:	Activation of the digital ignition
Reset:	Resetting the PTCarPhone to factory settings
Intercom:	Activation of the hands-free system for the intercom
Extras:	Activation of purchase features
WiFi:	Configuration of the WiFi hotspot

Configuration of the USB Interface

The mini USB socket of the electronics box of the PTCarPhone can be used for maintenance works by service technicians. The standard setting is **Service**.

When using the PTCarPhone devices as a modem, the interface must be switched to **Modem**.

System > Configuration > device code input > USB interface

Options

Modem, Service

Setting up Usage Restrictions (Operation Modes)

Four operation modes allow for restricting the usage of the phone step by step.

System > Configuration > device code input > Operation mode

Options

- Operation mode 0: In this mode the device works like a normal phone. There are no restrictions on the handset's menu tree. This is the active mode when the device is issued.
- Operation mode 1: This mode restricts the use of the phone in terms of its phone book. Only the already configured phone book is available and copying of contacts from the SIM card is locked. There are however no restrictions on dialling and sending messages via the keypad.
- Operation mode 2: All the phone book functions are the same as in operation mode 1. Dialling via the keypad is restricted to emergency numbers and phone numbers from the phone book. Only enabled numbers of the phone book can still be dialled. These restrictions also apply to the sending of messages.
- Operation mode 3: The restrictions of operation mode 2 apply here as well. Additionally, receiving calls is restricted to phone numbers which are listed in the phone book. These restrictions do not apply to receiving messages.



TIP:

Configure the phone book in operation mode 0 and then switch to operation mode 1, 2 or 3.

Overview operation modes

Operation modes	Phone book	Copying contacts from the SIM card	Dialling restrictions exist	Restrictions on receiving calls
0	x	x		
1	x			
2	x		x	
3	x		x	x



NOTE:

In operation mode 1, 2 and 3 the phone can only be used restrictively. This is a security feature, which is especially suitable for fleet vehicles as a cost-saving measure.

Changing the Delay Timer

The delay time starts, when the ignition is switched off. If a key on the phone is pressed during the delay time, the delay timer restarts.

System > Configuration > *device code input* > Delay timer

Options

0 min (the device is powered down, when the ignition is turned off), 5 min, 15 min, 1 h, 2 h, 4 h, 8 h, 12 h, 1 d, 7 d, 10 d or 30 d (min = minute/s; h = hour/s; d = day/s)



NOTE:

When the feature Virtual Ignition was activated, the delay time starts after switching off the engine of the vehicle.

Activation of the Virtual Ignition

If the PTCarPhone was installed correctly, it powers up automatically when the ignition of the vehicle is started. For modern vehicles without ignition wiring, the feature **Virtual Ignition** is intended. The Virtual Ignition detects changes in the power supply and powers the PTCarPhone up, when the engine is started.

System > Configuration > *device code input* > Virtual Ignition

Options

On: Automatic detection of the ignition

Off: Ignition over the true ignition contact (terminal 15)



NOTE:

This setting needs to be done only once, during the PTCarPhone installation.

Resetting the PTCarPhone to Factory Defaults

System > Configuration > *device code input* > Reset

Options



No, Yes (confirmation message)









CAUTION:

The phone will be reset to factory defaults. All data and settings stored on the phone will be deleted!

Digital Inputs and Outputs (I/Os)

The PTCarPhone offers six digital inputs and outputs. Each connection can be used either as an input as well as an output. Inputs are marked with a green sign , outputs are marked with a red sign .

System > Configuration > device code input > Digital I/O

Digital I/O 1	
Digital I/O 2	
Digital I/O 3	
Digital I/O 4	
Digital I/O 5	
Digital I/O 6	

Options

Digital input:

- Panic key (*E/A 2 and 6 only*)
- Sending SMS
- Hangup/Answer call
- Volume +
- Volume -
- PTT (only displayed when the Extra “PTT” was activated)

Digital output:

- Ring indic.
- Phone ON
- Active call
- Switch

Reset

Detailed information on the topic digital inputs and outputs can be found in the Application Note 1906: “I/O Interface Manual for the Plattform 6 Product Family”, available for download on: www.peitel.de.

Activation of the Hands-Free System for the Intercom Function

When the hands-free system is to be used occasionally instead of the handset I when talking over the intercom, this function needs to be activated in the phone menu. If activated, when the handset is put into the cradle during an intercom call, the hands-free system will take over.

System > Configuration > device code input > Intercom > Hands-free

Options

On, Off



NOTE:

To avoid acoustic feedback, enabling this function is only recommended, when the second handset and the hands-free system are located in separate rooms.

Activation of Purchase Features

Purchase features add extra functionalities to the phone. In the Extras menu, purchase features are marked as follows:

- Locked purchase feature (using the function key Update will unlock the purchase feature, provided that it was purchased from pei tel for this particular PTCarPhone.)
- The purchase feature is unlocked, but not activated.
- The purchase feature is unlocked and activated.



NOTE:

When buying purchase features, the IMEI number of the PTCarPhone needs to be send to pei tel.

Activation of Purchase Features:

System > **Configuration** > *device code input* > **Extras** > **Features** > *Purchase Feature*

Options

On, Off

Purchase Features

Automatic Redialing

If a call is interrupted, the phone will re-establish the connection automatically. This function is active as long as a call is not ended using the end key . When Automatic Redialing is activated, toggling calls is not possible. There is no Automatic Redialing after a Hidden Emergency Call.

Hidden Emergency Call

If the external panic key is pressed, an emergency call is generated, that won't show on the phone's display. The hands-free microphone is activated, the speakers are deactivated and any input on the handset is ignored. The receiver can listen in to the vehicle's interior. The call is either ended by the receiver or by pressing the key for more than 3 seconds. For using this feature, a digital input (2 or 6) with panic key and phone number needs to be installed.

PTT Feature (Push to Talk)

The microphone of the PTCarPhone is permanently muted. Only when a button is pressed, that is connected to one of the I/O ports, the mute function is deactivated for the period of time it is pressed. When the button is released, the microphone is muted again.

Setting up the WiFi feature

The device can be set up as a hotspot for WiFi. Enter an SSID (0-9 a-z A-Z _, 1-32 characters) and a password (0-9 a-z A-Z _, 8-64 characters). Next, activate the WiFi.

Factory default settings:

SSID (network name): PTC6_serial number

WiFi password: serial number

The WiFi is by default inactive.

Setting up WiFi:

System > Configuration > *device code input* > WiFi

Options

Enter SSID (SSID: Service Set Identifier, name your WiFi network)

Enter password

Press the function key **Next** to enter the respective configuration menu:

Options

Off, Mode b, Mode g, Mode n 2.4GHz

Use the function key **Select** to save your changes.

Speed Dial Menu

Adding Speed Dial Numbers

Nine speed dial numbers are available, respective to the input key numbers  1 to 9. Speed dial numbers can be allocated to single phone numbers of already created contacts.

Speed D. > *select free speed dial number* > function key Options > **Change** > function key OK > *select contact* > *select phone number*



TIP:

It is recommended to use the speed dial number “1” for the mailbox number, as the mailbox symbol is already printed on this key.

Deleting a Speed Dial Number

Speed D. > *select speed dial number* > function key Options > **Delete** > function key OK

Using a Speed Dial Number

Pressing an input key for a long time, which was associated with a speed dial number, starts the speed dial process. When “Direct call” is activated, dialling will start immediately. When “Direct call” is inactive, the speed dial entry will be shown and the call can be initialised with the function key Dial or with the call key .

See also “**Setting up Direct Call**” on page 34.

Settings Menu

Adjusting Display and Keypad Illumination

This menu point adjusts the illumination of the display and keypad. The setting **Perm. backlight** activates the illumination permanently. **Aut. backlight** switches the illumination of display and keypad off 10 Seconds after the last push of a key.

Settings > Display > Backlight

Options

Aut. backlight: Automated illumination: 10 Seconds after pushing the last key, the backlight is dimmed.
Perm. backlight: The illumination stays permanently switched on and is not dimmed.

Adjusting the Display Brightness

The display brightness can be adjusted to the present lighting conditions within a certain limit using the navigation keys ▲ and ▼. The handset beeps when the upper and lower limits of the adjustment range are reached.

Settings > Display > Brightness

Options

Active: Display brightness in illuminated state.
Inactive: Display brightness in dimmed state.

Call Settings

The call settings menu lists all settings for incoming and outgoing calls. Some settings are stored at the mobile phone provider's system (so called network services) and need to be retrieved over the mobile phone network, when the menu point is selected. As this might take some time, "Please wait" appears on the display. Network services depend on the mobile phone provider and might need to be registered or unlocked separately.

Settings > Call settings

Options

Sending own no.: Network service; If enabled, the own phone number might be displayed on the phone of the recipient of outgoing calls.
See also "**Calling Line Identification Restriction**" on page 27.

Call waiting: Network service; During a phone call a second incoming phone call is announced by a sound signal. It is possible to switch between the two phone calls back and forward (togglng). See also "**Call Waiting**" on page 27.

Automatic answer: Phone calls are forwarded automatically to the hands-free system after 2 or 5 ring tones. This feature is disabled (Off) by default.
See also "**Automatic Answer**" on page 27.

Incoming call: Decides, to which handset connection incoming calls are switched, provided, two handsets are connected to the system.
See also "**Incoming Call**" on page 28.

Call duration: Shows the total call duration of all incoming and outgoing calls. The call duration counter can be deleted. For this it is necessary to enter the device code.
See also "**Call Duration Display**" on page 28.

Settings Menu

Call divert: Network service; Call divert can be disabled and enabled. During the enabling process, a phone number needs to be provided. See also “**Setting up a Call Divert**” on page 28.

Calling Line Identification Restriction

The **Calling Line Identification Restriction** is set up by disabling (Off) the menu point “Sending own no.” This is a network service, which needs to be supported by the mobile phone provider.

Settings > Call settings > Sending own no.

Options

On, Off

Call Waiting

The network service Call Waiting can be turned on and off with this setting. A second incoming call is announced with a sound signal during a phone call. It is possible to toggle between the calls by pressing the function key Switch. This is a network service, which needs to be supported by the mobile phone provider.

Settings > Call settings > Call waiting

Options

On, Off

Automatic Answer

Automatic Answer makes it possible to answer calls during driving automatically, without touching the handset. However, it may be the case that callers are connected without the knowledge of the passengers, and thereby be privy to conversations taking place in the vehicle.

Settings > Call settings > Automatic answer

Options

Off: The Automatic Answer is disabled by default.

After 2 rings: After 2 ring tones incoming phone calls are forwarded to the hands-free system.

After 5 rings: After 5 ring tones incoming phone calls are forwarded to the hands-free system.

Incoming Call

This setting controls the behaviour of the phone when two handsets are connected. If only one handset is connected, the setting has no impact. If one handset is occupied by a call, the second handset is deactivated during this time.

Settings > Call settings > Incoming call

Options

- Handset 1: Incoming calls are diverted to the handset, which is connected to the handset socket on the electronics box marked with IF1.
- Handset 2: Incoming calls are diverted to the handset, which is connected to the handset socket on the electronics box marked with IF2.
- Both: Incoming calls can be answered on both handsets.

Call Duration Display

The total call time since the last deletion is displayed. The function key Delete can reset the counter. The device code is needed to deleting the call duration.

Settings > Call settings > Call duration

Setting up a Call Divert

Incoming calls can be forwarded to a specific phone number. This is a network service, which needs to be supported by the mobile phone provider. These settings are sent by the phone to the mobile phone provider and vice versa are retrieved from the provider when requested. This setting is disabled by selecting the setting "Off".

Settings > Call settings > Call divert > On

Options

- Add number: Add the call divert phone number with the input keys .
- From phone book: Add the call divert phone number by selecting it from the phone book.

Enabling the SMS Signal Tone

The SMS signal tone is enabled and disabled by pressing the function key OK.

Settings > Signals/Tones > SMS signal tone

Adjusting the Ringer Volume

The ringer volume is adjusted by pressing the navigation keys  and .

Settings > Signals/Tones > Ringer volume

Settings Menu

Selecting a Ring Tone Melody

10 melodies are provided to be selected as a ring tone.

Settings > Signals/Tones > Ring tone

Options

Selecting a melody: Press the navigation keys ▲ or ▼.

Play and save: Press the function key OK.

Setting the Sensitivity for the Hands-free Microphone

The sensitivity of the hands-free or external microphone can be adjusted as needed, depending on the background noises of the vehicle. Please note that increasing the microphone sensitivity might lead to acoustic feedback between speaker and microphone, depending on the installation situation in the vehicle.

Settings > Signals/Tones > device code input > Ext. Microphone

Options

0 dB, +3 dB, +6 dB, +9 dB, +12 dB, +15 dB, +18 dB, +21 dB

Security Codes

Settings > Security

Security codes which are stored on the PTCarPhone or on the SIM card:

Code	Intended Purpose	Standard	Origin	Length
PIN	Protects the SIM card from misuse; editable	See SIM card documents	Mobile phone provider / SIM card	4 to 8 characters
PUK	Unlocks the SIM card after putting in a wrong PIN three times; not editable	See SIM card documents	Mobile phone provider / SIM card	8 characters
Device code	Changing of system settings and for software updates; editable	0000	PTCarPhone	4 to 8 characters



NOTE:

It is recommended to change the device code.

Select a PIN Code Request Mode

A SIM card has only two settings for the PIN code request: **On** and **Off**. To ensure that the PTCarPhone is not switched on automatically when the vehicle is started, the PIN code is requested and the PTCarPhone menu adds another setting, **Automatic**. When selected, the SIM card remains secure by a PIN request (setting: **On**), but entering the PIN is done automatically by the PTCarPhone.

Settings > Security > PIN code request



NOTE:

In cases where the SIM card is replaced or the PIN on the SIM card was changed on another device, the PIN entry will fail and the phone will ask for a manual PIN entry. The PIN code request mode will then be set automatically to the default setting **On**.

Options

- On:** PIN entry required at phone start-up.
This setting is saved to the SIM card.
- Off:** PIN entry not required.
This setting is saved to the SIM card.
This setting is not supported by all SIM cards due to security risks.
- Automatic:** The PIN entry at start-up is done by the PTCarPhone automatically.
On the SIM card, the PIN code request setting is set to **On**.

Changing the Security Codes

The PIN on the SIM card and the device code can be changed individually.
See also ““**Changing the Security Codes**” on page 30.

Settings > Security > Change codes

Options

Change PIN code, Change HS code (HS: handset; device code of the PTCarPhone)



NOTE:

Security codes cannot be changed without the current code.

Automatic Network Selection

The default Automatic setting in the Network menu is generally recommended when selecting a mobile phone network manually is not required.

Settings > Network > Automatic

Options

- Enabled : Press the function key OK to enable this feature.
- Disabled : This feature is disabled by selecting a mobile phone network in the “select from list” menu.

Settings Menu

Selecting a Mobile Phone Network

When close to national borders, it might be necessary to select a fixed mobile phone network to prevent the occurrence of roaming charges for calls over foreign mobile phone networks.

When **Select from list** is selected, the PTCarPhone searches for available mobile phone networks. Networks marked with a green mark ● can be selected, networks marked with a red mark ● cannot.

Settings > Network > Select from list

Selecting a Network Technology

To solve reception problems, it might make sense to select a network technology permanently.

Settings > Network > Technology

Options

2G, 3G, Automatic

Internet Access Configuration

An internet connection is required for Over-the-air software updates. The access data for the internet portal of the mobile phone network need to be entered. For many mobile phone providers, the access data is already stored in the PTCarPhone. In other cases, access data needs to be added manually.

Settings > Internet

Options

MCC/MNC: Mobile Country Code / Mobile Network Code

APN: Access Point Name

Login: User Name

Password: User Password



TIP:

To exit the menu, use the function key OK to store modifications. Otherwise, exit the menu using the end key .

Settings Menu

Setting Date and Time

There are several display modes for time and date for choice. After confirming the selected display mode with the function key OK, you will be prompted to enter the time or date. The input is done using the input keys .

Settings > Date/Time

Options

Time: 24 hours mode, 12 hours mode

Date: DD.MM.YY, MM/DD/YY, YY-MM-DD

DD: Day (01 – 31), MM: Month (01 – 12), YY: Year (00 – 99)



TIP:

When setting the time in 12 hour mode, use the navigation keys ▲ or ▼ to toggle between “am” (mornings between 00:00 and 11:59) and “pm” (afternoons between 12:00 and 23:59).

Changing Date and Time Display Modes

After selecting the date or time display mode, the time or date is displayed and can be modified if necessary. See also “**Setting Date and Time**” on page 32.

Settings > Date/Time

Options

Time: 24 hours mode, 12 hours mode

Date: DD.MM.YY, MM/DD/YY, YY-MM-DD

Language Selection

The default setting **Automatic** will use the language setting from the SIM card. If this language is not available, English is selected automatically. Alternatively, languages can be selected manually.

Settings > Language

Options

Automatic, German, English, French, Italian, Spanish, Dutch, Swedish, Finnish, Romanian, Norwegian, Polish

Settings Menu

Phone Book Settings

The PTCarPhones phone book doesn't show contacts which are stored on the SIM card. However, it is possible to import contacts from the SIM card to the phone book.

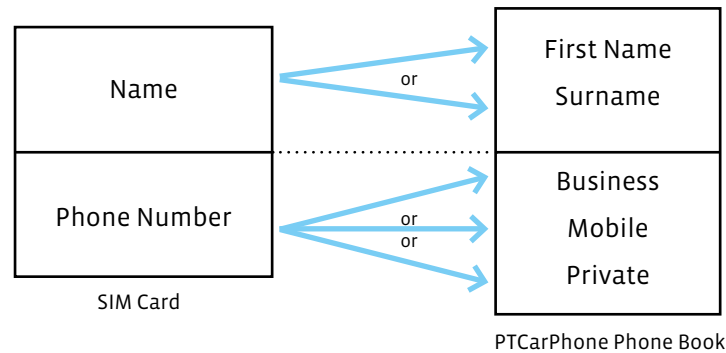

Copying contacts from the SIM card to the PTCarPhone:



Settings > Phone Book

Options

Memory status: Lists the total amount of storage spaces for contacts on the SIM card and in the phone book memory and how much is already occupied.

Copy SIM: Copies all contacts from the SIM card to the phone book memory. During this process, it is necessary to decide whether the names of all contacts on the SIM card are stored as first names or surnames and if all phone numbers are sorted into in one of the categories business , mobile  or private .

Display order: Decides if the phone book is sorted alphabetically by first name (first, last) or by surname (last, first).

Access Memory Status

This menu point lists the amount of free and total storage spaces for contacts in the PTCarPhone phone book and on the SIM card.

Settings > Phone book > Memory status

Example:

Phone book maximum: 5000 free: 4988
SIM maximum: 250 free: 238

Settings Menu

Copying Phone Numbers from the SIM Card to the Phone Book

Imports the contacts from the SIM card to the phone book of the PTCarPhone.

Settings > Phone book > Copy SIM



NOTE:

All decisions made during this process are made once for all contacts.

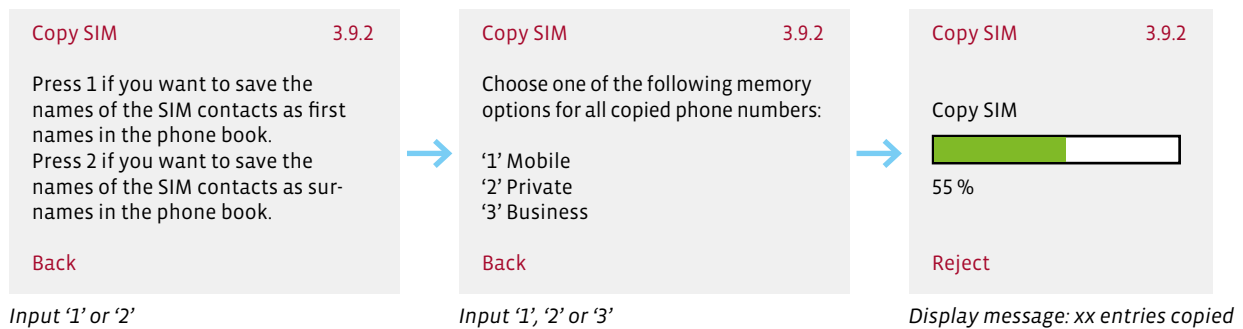

Sorting Contacts by First Name or Surname

Decides if the phone book is sorted alphabetically by first name (first, last) or by surname (last, first).

Settings > Phone book > Display order

Options

First, last

Last, first



Setting up Direct Call

The **Direct call** feature determines how the phone acts when an input key , which is associated with a speed dial number, is pressed down for a certain time.

Settings > Speed Dial

Options

Direct call enabled : The call starts directly after pressing the respective input key  for a certain time.

Direct call disabled : After pressing the respective input key  for a certain time, the speed dial entry is shown. To dial press the function key Dial.

Accessing SMS Settings

The SMS settings offer the possibility to enter or change the SMS Centre as well as to select whether sent SMS are stored on the phone.

Settings > SMS

Options

- SMS Centre: The SMS Centre phone number of the mobile phone provider can be entered or changed. It is recommended to leave this menu by pressing the function key OK.
- Send & Save SMS: When enabled, SMS are stored in the SMS memory after sending. See also **“Opening Saved SMS Messages”** on page 39.



Editing Contacts in the Phone Book

Contacts in the phone book can be deleted or edited, or new contacts can be added. Select a contact with the navigation keys and then press the function key Options.

Phone book > function key Options

Options

Delete contact: A contact is deleted from the phone book. Just confirm the message “Delete entry?” with the function key Yes.

Edit contact: First name, surname and phone numbers for the categories business , mobile  or private  can be changed or added. First, first name and surname are displayed. Pressing the function key Next opens the phone number window.

Add contact: A new contact is added. The boxes for first name, surname, business, mobile and private are empty.



NOTE:

- At least one name and one phone number are necessary for the contact to be able to be stored.
- In cases where no changes were made, exit the options **Edit contact** or **Add contact** using the end key .

Writing an SMS Message

SMS are written in the SMS text editor window.

SMS > Write > SMS text editor

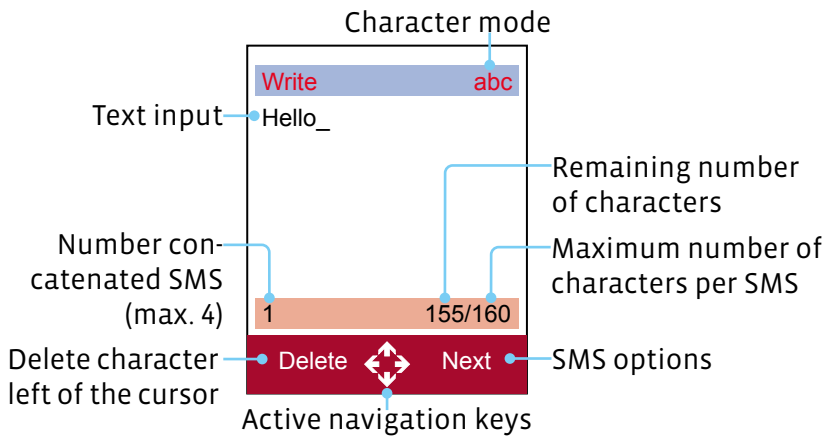

Character mode: The upper right corner displays **ABC** if upper case, **abc** if lower case or **Abc** for word capitalisation.

Remaining number of characters: Is reduced by 1 for every character input.

Maximum number of characters per SMS: Maximum number of characters for a single SMS.

Concatenated SMS: To extend the maximum number of 160 characters per SMS, up to 4 SMS can be automatically stringed and sent together. The “Remaining number of characters” and the “Maximum number of characters” always apply to the respective single SMS. The second, third and fourth SMS consist for technical reasons of less than 160 characters.

During the input, a black text field appears on the lower border of the display showing the available characters for the input button in use. See also “**Editors**” on page 12.

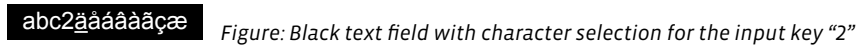

Draft SMS which are not sent, stored or erased remain in the SMS text editor window.

SMS > Write > SMS text editor > function key Next

Options

- Sending SMS: Send a SMS to a contact or phone number
- Save SMS: Save SMS for later use
- Erase SMS: Delete SMS

Opening Received SMS Messages

When receiving an SMS, the SMS symbol  is displayed in the toolbar of the display. When enabled, a SMS signal tone sounds. See also “Enabling the SMS Signal Tone” on page 28.

SMS > **Inbox** > function key **Select**

Options

Delete, Answer, Forward, Call-back, Save number, Save SMS

Deleting SMS Messages

Draft SMS or saved SMS can be deleted as follows:

Open the SMS, then:

Function key **Next** or **Options** > **Delete SMS** or **Delete** > function key **Yes**

Replying to SMS Messages

Replies can only be sent to SMS which are in the inbox.

Open the SMS, then:

Function key **Options** > **Answer** > *write the answer* > function key **Send** > *edit phone number if necessary* > function key **Send**

Forwarding SMS Messages

Only SMS stored in the inbox or SMS archive can be forwarded.

Open the SMS, then:

Function key **Options** > **Forward** > *edit SMS if necessary* > function key **Next**

Options

Add number: The phone number is entered using the input keys

From phone book: The phone number is selected from the phone book

Calling a Phone Number Retrieved from an SMS Message

This is only possible for SMS stored in the inbox.

Open the SMS, then:

Function key **Options** > **Call-back**

Saving a Phone Number from an SMS Message

The phone number can only be saved from SMS stored in the inbox.

Open the SMS, then:

Function key Options > **Save number** > function key OK > *enter first name and surname* > function key Next > *select a category* > function key Select > *another phone number might be added* > function key Next

Phone number categories: business , mobile  or private 

Saving SMS Messages

SMS can be saved directly after writing or when they are stored in the inbox. To save sent SMS to the SMS archive, see (SMS settings).

Open the SMS, then:

Function key Next or Options > **Save SMS** > function key OK

Retrieving the Memory Status

The phone can store up to 50 SMS in total, either in the inbox, or in the SMS archive. It is recommended to delete older SMS on a regular basis.

SMS > **Memory status** > function key OK

Opening Saved SMS Messages

SMS > **SMS archive** > *select SMS* > function key Select

Options

Delete, Forward

Call Register Menu

Opening the Call Register

The last ten calls are registered in each category (list), consisting of **Missed calls**, **Received calls** and **Dialled numbers**. The phone menu offers the possibility to delete one or more lists or to dial or store phone numbers in the phone book.

Call register > *select list* > *select an entry* > function key Options

Options

Save to phone book: Use the phone number of a selected call register entry to add a new contact.

Sending SMS: Send an SMS to the phone number of a selected call register entry.

Dial number: Dial the phone number from a selected call register entry.



NOTE:



Calls with unidentified phone number are marked as anonymous. In this case, options are not available.

Saving a Phone Number from the Call Register

Selecting the phone number from the call register and opening the phone book editor:

Call register > *select list* > *select entry* > function key Options > **Save to phone book** > function key OK

Saving the phone number in the phone book:

1. Enter first name and surname.
2. Press the function key Next.
3. The category (business , mobile  or private ) for the phone number can be chosen using the navigation keys ▲ or ▼ and saved with the function key Selection.
4. If required, additional phone numbers can be added to the other free categories.
5. Press the function key Next to save the contact.

Calling a Phone Number from the Call Register

Selecting a phone number from the call register and opening the phone book:

Call register > *select list* > *select entry* > function key Options > **Dial number** > function key OK

Sending an SMS Message to a Phone Number from the Call Register

Selecting a phone number from the call register and opening the phone book:

Call register > *select list* > *select entry* > function key Options > **Sending SMS** > function key OK > edit SMS if required > function key Send > edit phone number if required > function key Send

Redialling

To repeat a call, select the call register **Dialled numbers**, select the last call and press the call key .

Call register > Dialled numbers



TIP:

The call register **Dialled numbers** can also be opened from the main menu by pressing the call key .

Deleting Call Register Lists

Select one or more call register lists with the navigation button and select them by pressing the function key OK. Once all are selected, press the function key Delete.

Call register > Delete list



NOTE:

When deleting call register lists, all contained data will be permanently deleted!





TIP:

Use the function key OK to remove already selected call register lists from the selection.

Toggling

When the function “Call Waiting” was activated, it is possible to switch between an active call and a waiting call back and forward.



Use the following keys for this feature:

- End key : The waiting call is rejected, or, a call on hold is hang up.
- Call key : The waiting call is accepted and the active call is hang up.
- Function key Switch: The waiting call is accepted and the active call put on hold. Use this key to switch between active and on-hold call back and forward.

See also “Call Waiting” on page 27.

Features of the GPS Module

The GPS icon in the symbol bar of the display represents the strength of the GPS reception as shown below:

	GPS: No satellite
	GPS: 2D-Fix
	GPS: 3D-Fix

Please find more information on GPS in the technical documentation „AN1905: Platform 6 Command Description Manual“. This documentation is available for download on www.peitel.de.

Setting the Time via GPS

When the GPS module contacts the global satellite system for the first time, the PTCarPhone receives the UTC time and, if the time was not set up manually, is shown on the display. The difference between the received UTC time and the time setting is stored on the PTCarPhone and applied at the next start-up.

The Second Handset

With the second handset, which is offered as an accessory item, calls can be forwarded from one handset to the other and intercom calls can be made between the two handsets. For call settings for the second handset, see “Incoming Call” on page 28.



NOTE:

- When both handsets are connected, software updates will be applied to both handsets.
- The handset which is plugged into the socket on the electronics box marked with “IF1” is connected to the hands-free system.
- SMS are displayed on both handsets.

Forwarding a Call from one Handset to the Other

Use the function key **Internal** to forward a call from one handset to the next. The forwarded call will be announced on the other handset by a tone signal and needs to be accepted by pressing the function key **Answer**. The handset not in use is switched to inactive mode during a call. On the display the message “occupied” appears. Both handsets can be used for phone calls, just not in the same time.

The Intercom Feature

The intercom feature enables internal calls between the two handsets. To start a call over the intercom, press the call key  for more than a second. On the other handset, an incoming call is announced by a tone signal and needs to be confirmed by pressing the function key **Answer**. The message “Intercom” appears on the display of both handsets. To end the intercom call, press the end key .

See also “**Activation of the Hands-Free System for the Intercom Function**” on page 22.

Using the PTCarPhone as a Modem

To use the PTCarPhone as a modem for an internet connection, the USB interface needs to be set to “Modem”, see also “**Configuration of the USB Interface**” on page 20.

In-depth instructions for setting-up a dial-up connection can be downloaded from: www.peitel.de.

Additional Information

Scope of supply

Components of the scope of supply:

- Electronics box (TPU)
- Handset HA59 with cradle
- Loudspeaker
- Hands-free microphone
- 2.5 m extension cable for handset
- Cable set
- Quick reference guide and installation instructions

Accessories

Accessories for the PTCarPhone Series:

- Handset HA59 incl. 5.0 m extension cable
Article number: 6508-006-100-51
- I/O cable installation set (12x 200 mm strand and plug housing)
Article number: 6708-004-000-00
- 2.5 m extension cable for the handset
Article number: 6098-260-005-51
- 5.0 m extension cable for the handset
Article number: 6098-260-007-51

Care and Cleaning Tips

Switch off the PTCarPhone for all cleaning purposes.

It is recommended to use a paint brush or a fine brush to remove dust particles from the hands-free microphone, the external speaker or the handset.

To remove stubborn dirt, use a damp, soft, lint-free cloth. Make sure that no liquids penetrate the housing.

Never use harsh chemicals, cleaning agents, abrasive cleaners, or soaked cloths or sponges.

It is generally recommended to keep the surroundings of the equipment free from dust.

Technical Data

LTE module

- Frequency bands Europe model:
LTE: B1(2100), B3(1800), B7(2600), B8(900), B20(800), B28A(700)
UMTS: B1(2100), B3(1800), B8(900)
GSM: B3(1800), B8(900)
- Frequency bands North America model:
LTE: B12(700), B14(70), B4(1700), B2(1900), B5(850), B13(700), B66(1700/2100), B71(600)
UMTS: B2(1900), B4(1700), B5(850)
- VoLTE support
- Satellite navigation:
GPS, Glonass, Beidou, Galileo, QZSS
- Power for 850/900 MHz 2 watt
- Power for 1800/1900 MHz 1 watt
- Power for UMTS max. 0.25 watt
- Power for LTE max. 0.2 watt
- Emergency call function (112/911)
- SMS capability
- Concatenated SMS (up to 4 x 160 characters per message)

Data transmission LTE Cat. 4

- Uplink up to 50 Mbps
- Downlink up to 150 Mbps

Interface

- RS232 with V24 level
- Baud rate: 115200
- Parity: none
- Data bits: 8
- Stop bits: 1
- Handshake: OFF

Operating Voltage

10 V to 32 V

Additional Information

Power Consumption

- Off < 0.07 watt
- Standby: about 1.5 W to 3 W (depending on connected accessories)
- Max. power consumption during hands-free mode: 2 A

Temperature

Operating: -20 °C to 70 °C
Storage: -30 °C to 80 °C

Fuses

- Fuse for permanent positive: 5 A mini blade type fuse
- Fuse for ignition: 2 A mini blade type fuse

Antennas

Connectors: SMA (two for LTE antennas (MIMO), one for the GPS antenna, one for the WiFi antenna)

Four antennas with SMA connector are required for the operation of the phone, WiFi and satellite navigation. The antennas are not included in the scope of delivery.

 **NOTE:** Be aware of the antennas' installation conditions in the vehicle. Please contact your qualified installation partner with any questions. If you are looking for suitable antennas, please contact pei tel.

Approvals

E-Mark

 10R05/01 3121 00

USA

FCC ID 2AU9JPTC6

This device complies with part 15 of the FCC Rules. Operation is subject to the following two conditions:

- (1) This device may not cause harmful interference, and
- (2) this device must accept any interference received, including interference that may cause undesired operation.

This equipment has been tested and found to comply with the limits for a Class B digital device, pursuant to

part 15 of the FCC Rules. These limits are designed to provide reasonable protection against harmful interference in a residential installation. This equipment generates, uses and can radiate radio frequency energy and, if not installed and used in accordance with the instructions, may cause harmful interference to radio communications. However, there is no guarantee that interference will not occur in a particular installation. If this equipment does cause harmful interference to radio or television reception, which can be determined by turning the equipment off and on, the user is encouraged to try to correct the interference by one or more of the following measures:

- Reorient or relocate the receiving antenna.
- Increase the separation between the equipment and receiver.
- Connect the equipment into an outlet on a circuit different from that to which the receiver is connected.
- Consult the dealer or an experienced radio/TV technician for help.

Canada

IC: 25691-PTC6, Hardware Version Number (HVIN: 01)

This device contains licence-exempt transmitter(s)/receiver(s) that comply with Innovation, Science and Economic Development Canada's licence-exempt RSS(s). Operation is subject to the following two conditions:

1. This device may not cause interference.
2. This device must accept any interference, including interference that may cause undesired operation of the device.

L'émetteur/récepteur exempt de licence contenu dans le présent appareil est conforme aux CNR d'Innovation, Sciences et Développement économique Canada applicables aux appareils radio exempts de licence. L'exploitation est autorisée aux deux conditions suivantes :

1. L'appareil ne doit pas produire de brouillage;
2. L'appareil doit accepter tout brouillage radioélectrique subi, même si le brouillage est susceptible d'en compromettre le fonctionnement.

Additional Information

Technical Details of the Connections

I/O connections

The electronics box is equipped with six programmable input and outputs (I/Os).

- Type: Open drain output with snubber diode / input with 15 kOhm pull-up resistor connected to the operation voltage of the device
- Only resistive and inductive loads permitted (no capacitive loads!)
- Maximum current: 100 mA per connection
- Max. voltage less or equal to the operation voltage of the device (but max. 32 V)
- Snubber diode for the relay (inductive loads) included; It is necessary to use the internal power supply (Pin 4, 5, 6) for this purpose

Radio mute output

- Type: Open drain output (switched to ground)
- Resistive loads permitted only!
- Maximum current: 50 mA
- Maximum against ground: +32 V

Disposal



The image of the crossed-out waste bin reminds you to dispose of waste electronic equipment separately from normal household waste.

Please don't dispose of your car phone and its accessories together with household waste, but rather bring it to a local recycling or collection centres.

Also, please dispose of packaging and documentation separately at your local recycling centre.

WEEE registration number DE 94398883

Declaration of Conformity



Please find the declaration of conformity on our homepage:
www.peitel.de

Support

- Answers to frequently asked questions are found in our FAQ at www.peitel.com.
- If you still have questions, please contact **Technical Support** at **+49 (0)3328 – 9363 299 (Monday to Friday, 9 am to 3 pm – CET)**
- If your device or an accessory needs repair, whether under warranty or following expiration of the warranty period, the device can be sent directly to pei tel.
For this purpose, please go to www.peitel.com and register your return in the support area.



NOTE:

- Before sending in the defective electronics box, please remove the SIM card, cables and accessories. Only send in the defective device.
- Please not, that in case of a repair, all data stored in the PTCarPhone (settings, contact and text messages) will likely be deleted.

Menu Overview

Menu headline 1.2.1.2
 Menu item (regular font)
Description / instruction (italic)
1.2.1.2: Menu numbering
Forward with function key:
 Extras
 Next

How to read the menu overviews

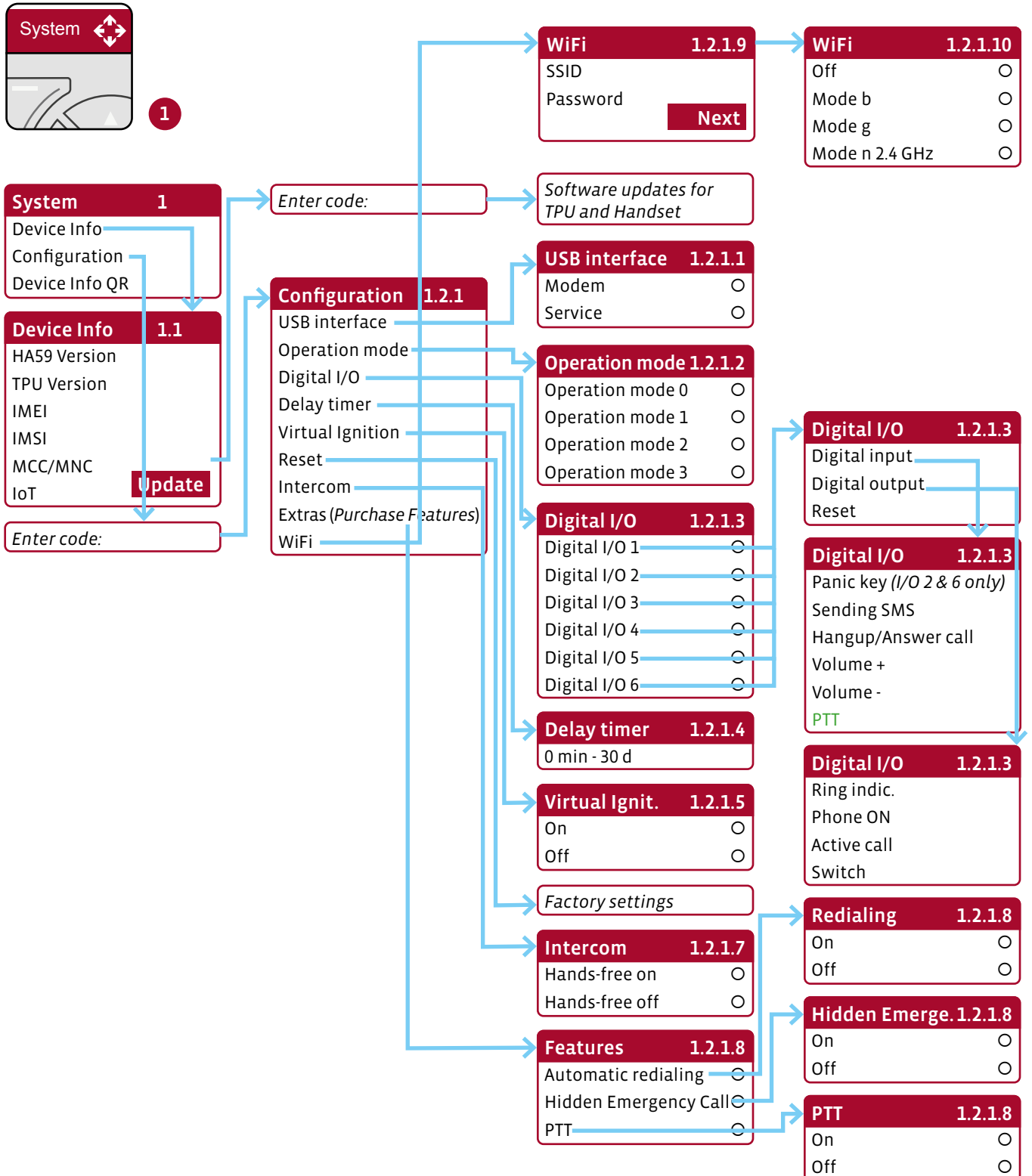

Menu Overview

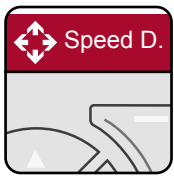

2

Speed dial 2

- 1 Adam
- 2 Bertha
- 3 No entry
- ...
- 9 No entry

Options

Options 2.1

- Change
- Delete

Select contact

Select phone number

Menu Overview



3

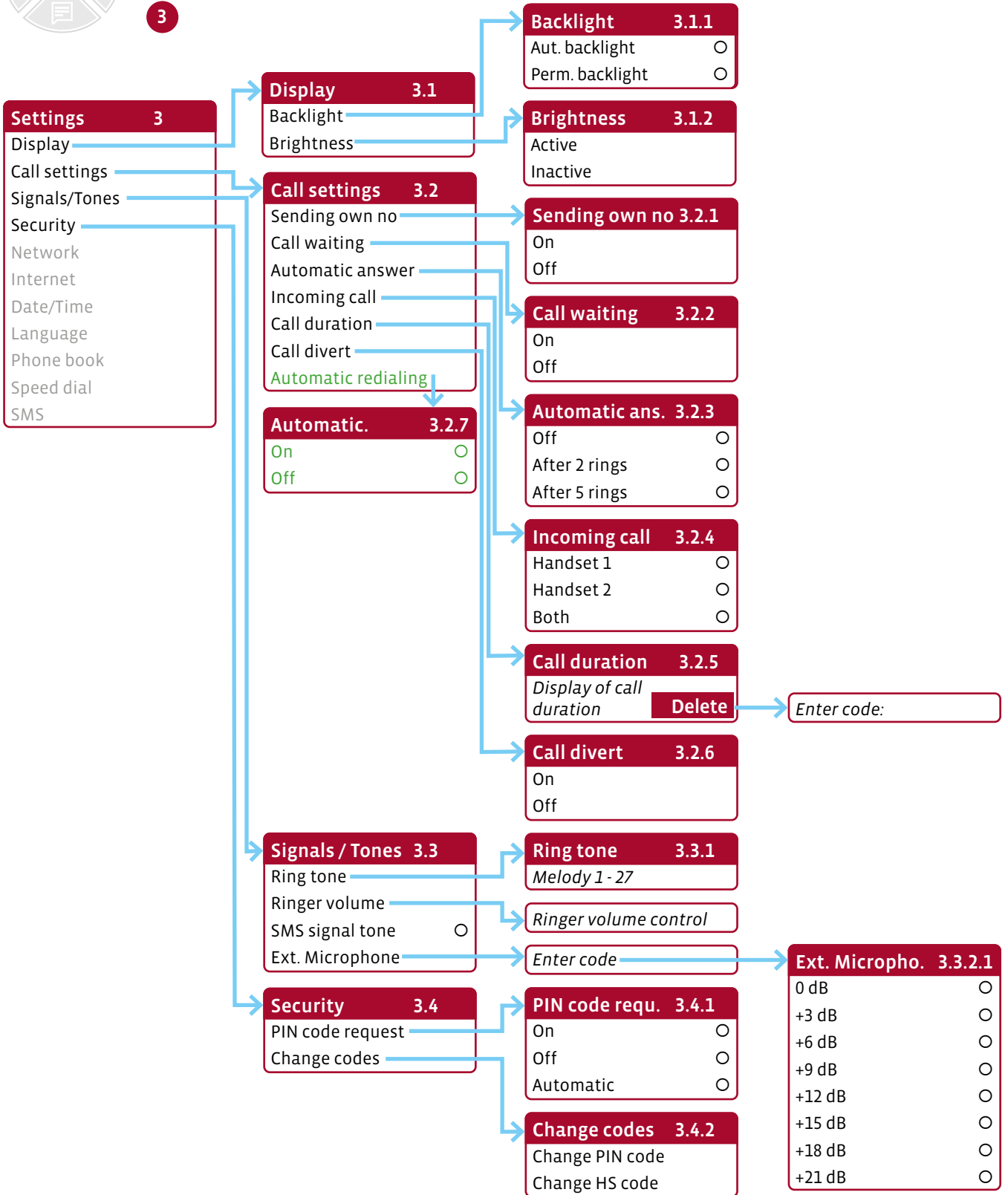

Menu Overview



3

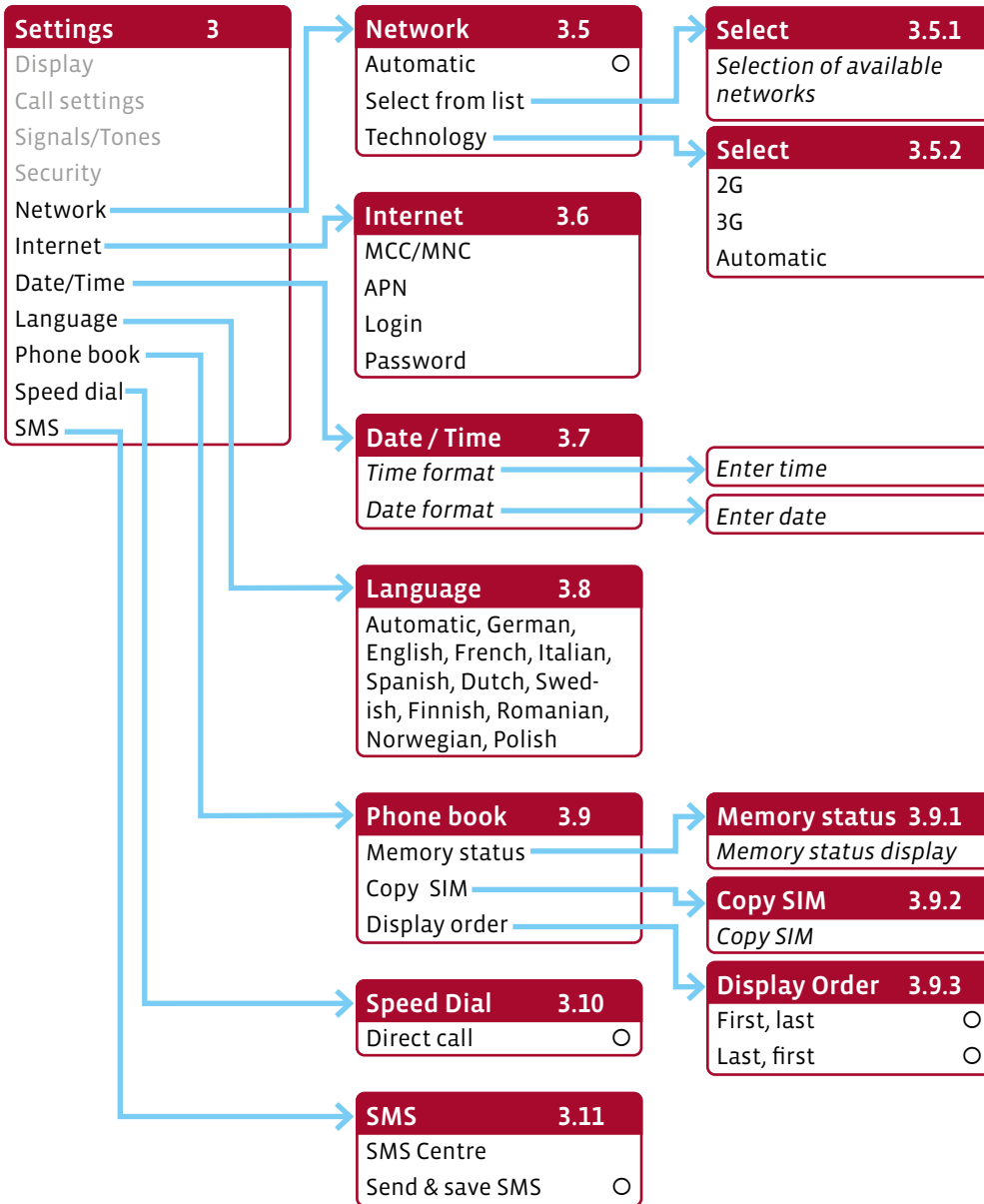

Menu Overview

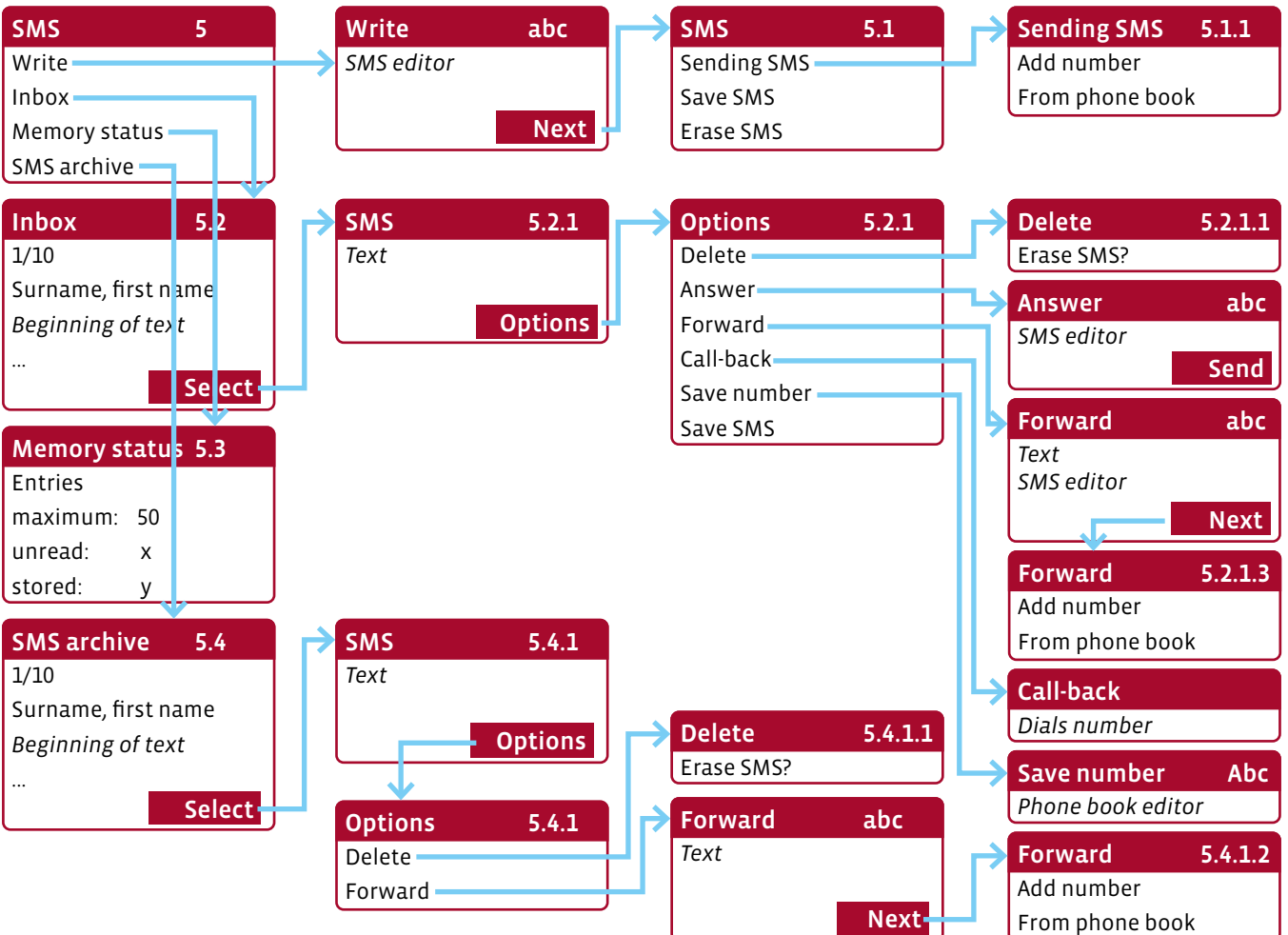
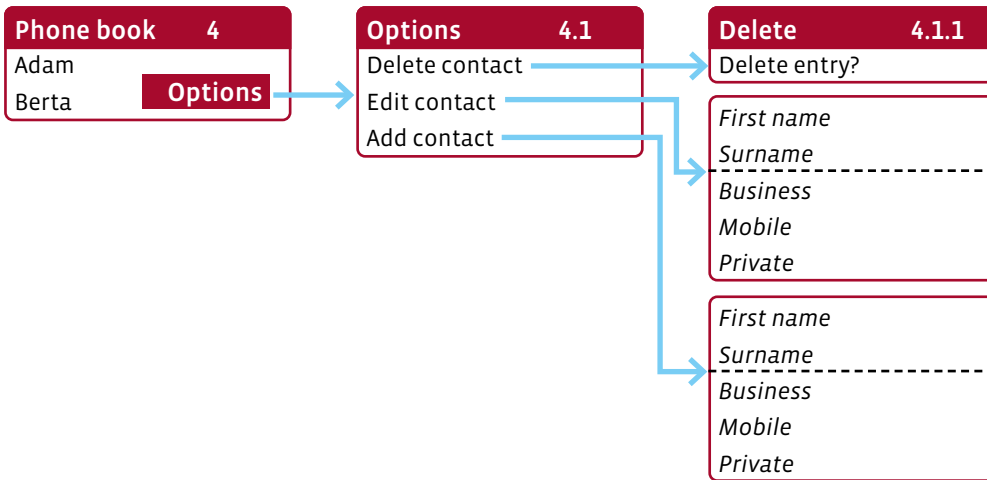



6

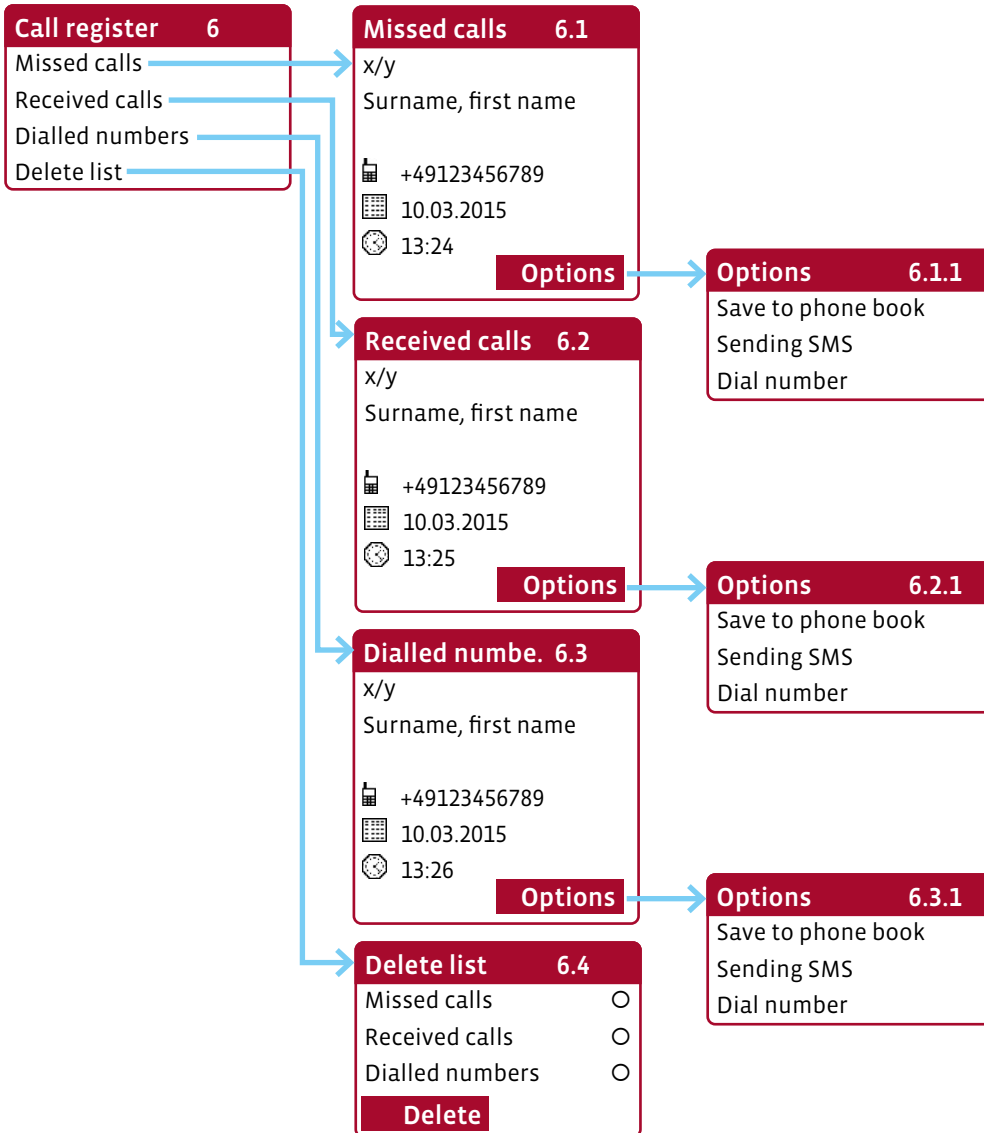

Imprint

Version: 08.06.2020

© 2020 pei tel Communications GmbH. All rights reserved.

pei tel Communications GmbH, Rheinstraße 15 A, 14513 Teltow, Germany

pei tel reserves the right to modify these instructions at any time, to correct typing mistakes or to add new functions in the course of technical progress or further development. Every current version of these instructions can be found on the Internet at www.peitel.com.

Legal Notes

pei tel accepts no liability for maintaining settings, data or text messages saved on the PTCarPhone. Some of the services, company names and trademarks given in these instructions are the property of the respective trademark owners.