

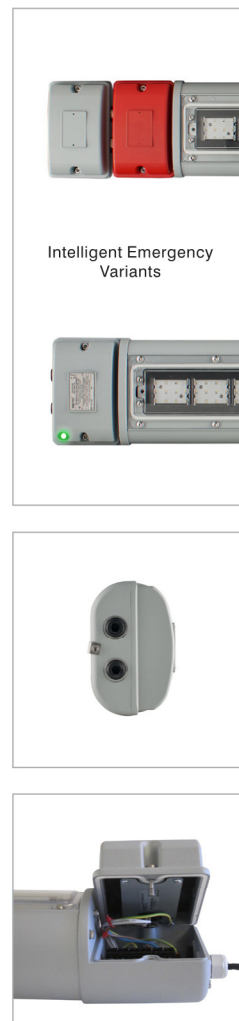

SPARTAN SPX-WL168 LED Zone 1/21 Linear Luminaire Nödljus







- ATEX and IEC Ex approved – Zone 1/21
UL/CSA approved, including C1D2 and ABS
- Zone 2 variants available
- Intelligent Emergency variants -
up to 100% light output
- Retrofittable
- Ultra long life, high lumen output LED
- Easy installation, maintenance and inspection
- Wide operating temperature range -40° to +55°C
- 5 year warranty
- 'Op is' approved (EN60079-28)

The SPARTAN Linear range is designed specifically for use in new hazardous area installations or to retrofit existing fluorescent installations which require high performance, reliable, White-Light illumination. Housed in marine grade aluminium and using Raytec's field-proven, long-life LED technology, SPARTAN Linear is ATEX and IEC Ex approved for all Zone 1/21 applications (Zone 2/22 variants also available). SPARTAN Linear's overall dimensions, fixing centres and gland entries are all compatible with traditional Ex e 2x18W fluorescent luminaires, so end users can upgrade to LED easily.

SPARTAN Linear is available as an intelligent emergency variant which self-tests the emergency battery to proactively monitor and maintain the overall health of the luminaire and provides class leading emergency performance. A unique modular design means key components are easily accessible, making inspection and maintenance quick and easy. **COOLEXTRUDE™** thermal management technology ensures the luminaire runs cool, providing up to 60% better heat dissipation compared to conventional lighting, allowing the product to operate for 10+ years while still delivering a high lumen output of 5,000 lumens.

Intelligent Emergency - Self-testing Functions

LED Indication	Condition
	Battery charged and PSU OK
	Emergency mode activated
	Function Test
	Self-test
	Commissioning
	Fault - further troubleshooting required

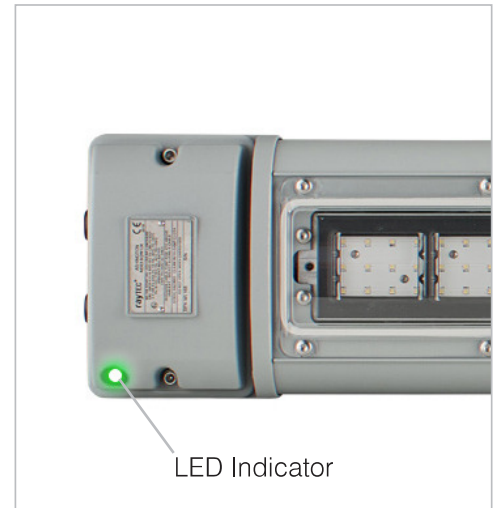

Features	Benefits
Retrofitable	Easy Installation, matching the dimensions of traditional 2x36W fluorescent fittings, to provide an easy direct replacement Equivalent Output to a 2x36W fluorescent
Intelligent Emergency	Self-testing emergency battery which proactively monitors and maintains the overall health of the luminaire Easy inspection thanks to a tri-colour LED indicator
Modular Design	Both the LED and PSU modules are easily accessible for maintenance and inspection
Ultra-Powerful	High lumen output – up to 5,000 lumens Latest high power LED technology
Ultra-Reliable	Industry leading 5 year warranty Designed and manufactured in the UK to the highest standards including both ISO9001 & ISO14001 Advanced electronics and LED's protected by vibration resistant and waterproof potting compound Intelligent emergency with automatic self-testing
Ultra-Efficient	COOLEXTRUDE™ thermal management delivers class leading energy efficiency Significant running and maintenance savings compared to traditional lighting technologies SMART access wiring system for safe and efficient installation, set-up and ongoing inspection
Support Services	Photometric files available (.ies & .ldt) Full Lighting Design Service Site specific Energy and Cost Saving Report available

5 YEAR WARRANTY

All Raytec luminaires are provided with an industry leading 5 year warranty and have an expected useful life in excess of 10 years



Technical Specifications

Certification

ATEX Rating:	ATEX and IEC Ex rated for Gas and Dust
Hazardous Area rating:	Zone 1 (Gas), Zone 21 (Dust)
Certificates:	CML14ATEX3119 & IEC Ex CML 15.0001 UL/CSA, including C1D2
Gas:	II2 G D Ex e mb op is IIC T5 Gb Ta= -40°C to +55°C (-20°C to +50°C for emergency variants)
Dust:	Ex tb op is IIIC T75°C Db Ta= -40°C to +55°C (-20°C to +50°C for emergency variants)
North America Rating:	Class I, Division 2 Groups A, B, C, D, T5 Class II, Division 1 & 2 Groups E, F, G Class III, Division 1 & 2 NEMA 4x, IP66/IP67 UL50E, UL8750, UL 1203 C22.2 No Emergency Variants - Certification Pending
ABS Rating:	ABS Certificate # 15-LD1364539-1-PD

Electrical

Input:	110-254V 50/60Hz AC only Low voltage: 18-48V AC and 18-69V DC Extra low voltage: 12V AC/DC
Power:	Standard - 68W Emergency - 71W
Termination	Incoming terminal block suitable for looping 4 core 4mm ² cable
Power Factor:	>0.95
Cable Entries	2xM20 cable entries at both ends, through wired as standard (other entries available upon request), dispatched complete with three ATEX/IEC Ex approved blanking plug 3/4" NPT as standard on C1D2

Optical

Lumen output on mains:	Up to 5,000 lm
LED type:	Platinum Elite SMT LEDs
Number of LEDs:	168 LEDs
CRI	80+
Colour Temperature:	6,000K+

Mechanical/Environmental

Burning position:	Universal
IP rating:	IP66 & IP67
Temperature range:	-40°C to +55°C (-20°C to +50°C for emergency variants)
Weight:	Standard - 9kg (19.8lbs) Emergency - 10kg (22lbs)
Enclosure:	Marine grade aluminium epoxy powder coated, UV stabilised polycarbonate, all external fasteners and brackets are marine grade stainless steel
Unit Colour:	Silver (RAL 9006) Red (RAL3024) - Emergency cover
Installation instructions:	Please contact Raytec for copy
Dimensions:	Standard - 1295 x 108 x 174mm (51 x 4.3 x 6.9") Emergency - 1414 x 108 x 174mm (55.7 x 4.3 x 6.9")
Mounting:	Via M8 tapped holes. Various mounting arrangements available (please see product overview guide)

Intelligent Emergency Battery Back-Up

Function:	Self-testing intelligent emergency
System health indicator:	Tri-colour LED indicator
Emergency Duration:	Up to 3hrs @ 25% power Other options available
Emergency Battery:	Ni/Cd 12V
Emergency Charge Time:	20 hours

Part Codes - Zone 1

Part Codes	Description
SPX-WL168	SPARTAN Zone 1 Linear, 168 LED, White-Light
SPX-WL168-EMX25	SPARTAN Zone 1 Linear, 168 LED, White-Light, Intelligent Emergency Battery Backup

18-69V variants available, add -LV to the above codes
12V variants available, add -ELV to the above codes
Add -D to part code for diffused lens
Contact Raytec for T5/T6 variants

Light Distribution

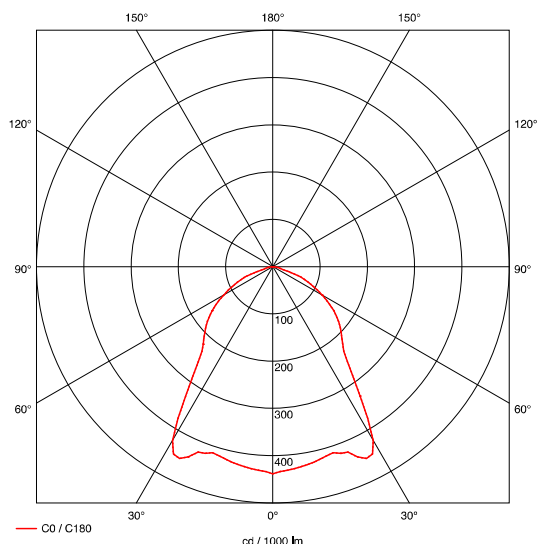

Product Dimensions

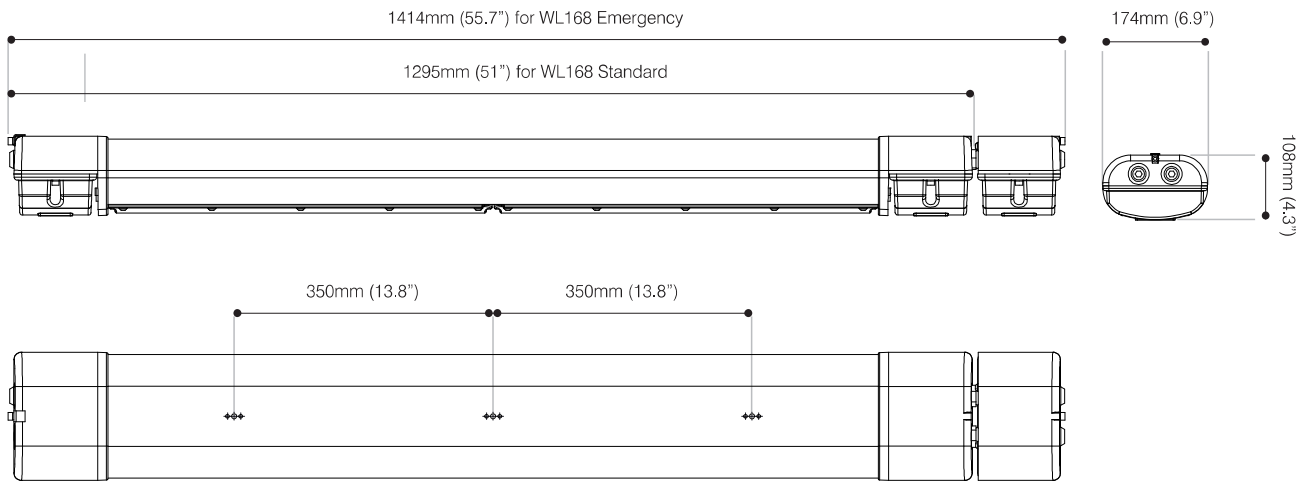

SPARTAN Linear Accessories



SUSPENSION CORD KIT



POLE CLAMP KIT



M8 EYE BOLT



CEILING MOUNTING KIT



SWIVEL MOUNT KIT



WALL MOUNTING OUTREACH BRACKET

Other accessories also available, including Magnetic Mounting Kit (SPX-BKT-MAG) and Tear Off Optic Strips - pack of 10 (SPX-BKT-PF84)

Products in the SPARTAN Family

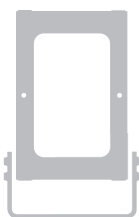

SPARTAN Flood



SPARTAN Linear

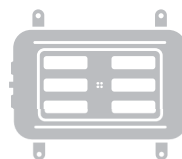

SPARTAN Bulkhead



SPARTAN Bay

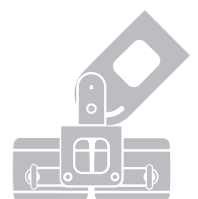

SPARTAN Crane